

GS20-GS30 Series

FIXED-SPEED PRESSURE BOOSTER SETS WITH
VERTICAL MULTISTAGE ELECTRIC PUMPS e-SV™ SERIES

CONTENTS

GENERAL INTRODUCTION.....	4
DESCRIPTION OF OPERATION	5
INSTALLATION.....	6
CHOICE AND SELECTION	7
GS../SV SERIES	13
ELECTRIC PUMP RANGE AND CHARACTERISTICS	15
HYDRAULIC PERFORMANCE TABLES	25
ELECTRIC DATA TABLES.....	31
GSD20 - GSY20 SERIES.....	33
GSD30 - GSY30 SERIES.....	41
PERFORMANCE CURVES	49
H _c PRESSURE DROP CURVE	73
ACCESSORIES.....	77
TECHNICAL APPENDIX.....	83

GS BOOSTER SETS SERIES

GENERAL INTRODUCTION - PRODUCT DESCRIPTION

The GS series pressure booster units mainly comprise electric pumping stations assembled with two or three SV series vertical multistage electric pumps. A smaller electric pump can also be added to the main ones. Generally known as a jockey electric pump, it provides for minor usages in order to maintain system pressure without starting the service electric pump.

The GS series pressure booster units are constant speed sets and are used to distribute water in heating or filling systems. On demand jockey electric pump informations are available. The electric pumps are mounted on a single base together with the other hydraulic components, such as on-off valves, check valves and the delivery and return manifolds.

The electrical panel, supplied with a mounting bracket, is attached to the pressure booster unit base.

The electric pumps start and stop according to the signals sent by the pressure transducer to the electrical control panel.

The latter is fitted with an integrated electronic board. The electric pumps start and stop automatically depending on the water demand of the system.

These pressure booster systems are combined with expansion vessels (hydrotube) in order to guarantee stable operation and reduce the starting frequency of the electric pumps.

For the correct choice in capacity of the expansion vessels, see the relative chapter on page 103 of the catalogue.

GS series booster sets with e-SV series electric pumps are certified for use with drinking water.

GS series booster sets are available with a wide range of electric pumps to satisfy the different needs of every system. GS booster sets are also available in special version to fit specific duty points and applications.

GS BOOSTER SETS SERIES DESCRIPTION OF OPERATION

The electric pumps start and stop according to the set pressures detected by the pressure transducer, thus ensuring the required amount of water is delivered. The pressure values can be directly set on the electronic board. For units with jockey electric pump, the latter will start first and stop last, depending on the set pressure values. When a tap is opened, the pressure starts to fall until it reaches the starting value of the first electric pump. If the delivery of water increases, the pressure falls even further and the other electric pumps start in sequence according to the demand for water.

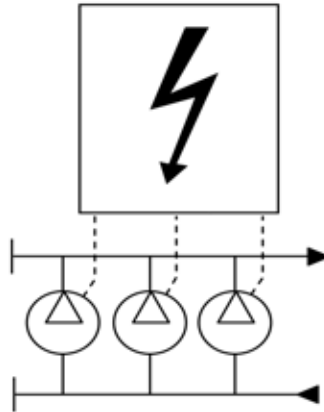

When consumption falls, the pressure in the system increases and the electric pumps stop when the set threshold pressure values are reached.

If consumption falls to zero user demand, the last electric pump also stops.

If the "timer" function is used, the last electric pump to work will remain operating for a set time after it is switched off, in order to reach maximum pressure. Make sure the maximum pressure is compatible with the system in which the pump is installed.

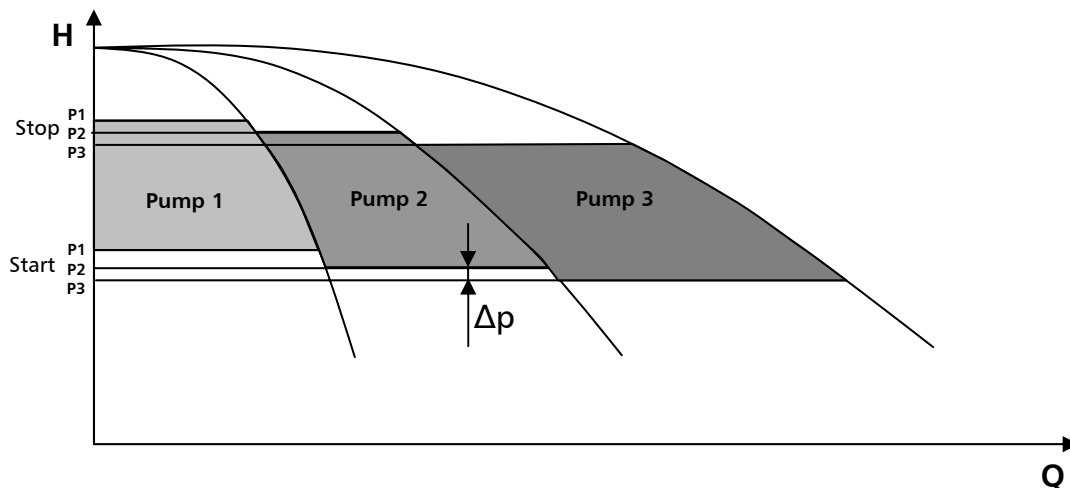

Example of operation.

Δp pressure differential between electric pumps, can be reduced to 0,5 bar.

GS BOOSTER SETS SERIES INSTALLATION

The booster sets must be installed in areas protected against frost and with adequate ventilation to cool the motors. It is a good practice to connect the booster set to the suction and delivery pipes of the system inserting vibration-damping joints to limit the transmission of vibrations and resonance to the system.

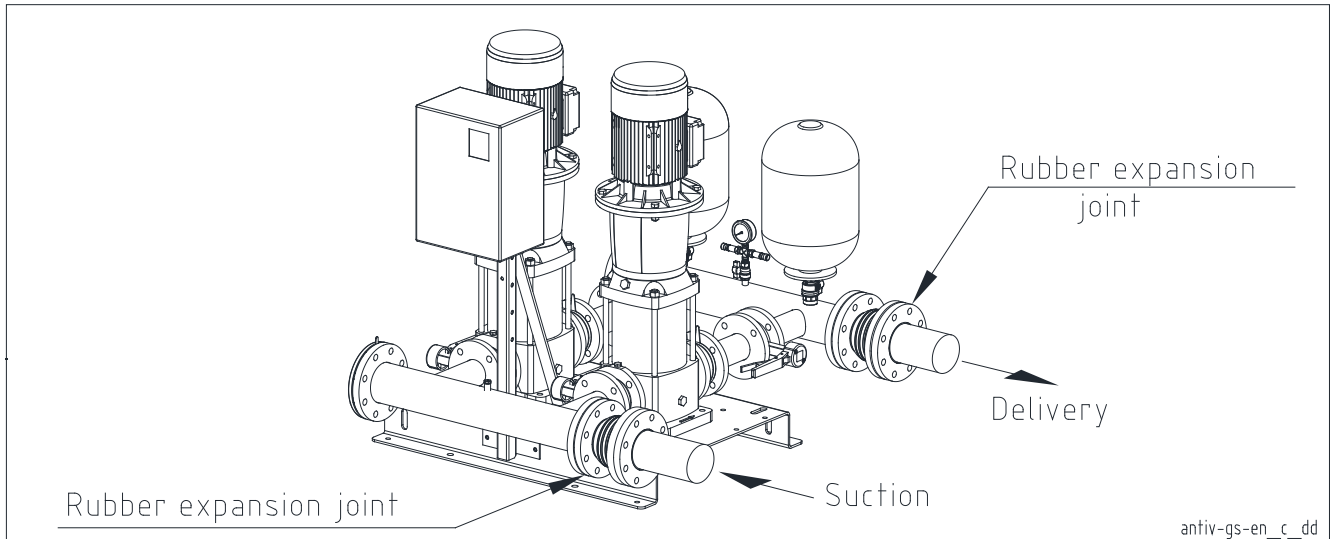

The booster sets must be connected to pressurised tanks with an adequate capacity for the system to be made. These tanks can avoid any problems due to water hammer that is created due to the sudden stopping of the electric pumps.

For this type of system, it is possible to install in the delivery piping diaphragm expansion vessels (hydro tube) that perform a pressure dampening function. It is always recommended to check the type of system to be made and choose the correct capacity of the vessels accordingly. The total volume could be divided into two or more vessels.

For the sizing of the expansion vessels, see the specific chapter in this catalogue.

It is good practice to check the value of the maximum electric pump pressure to match the set with a vessel suitable for the pressure value.

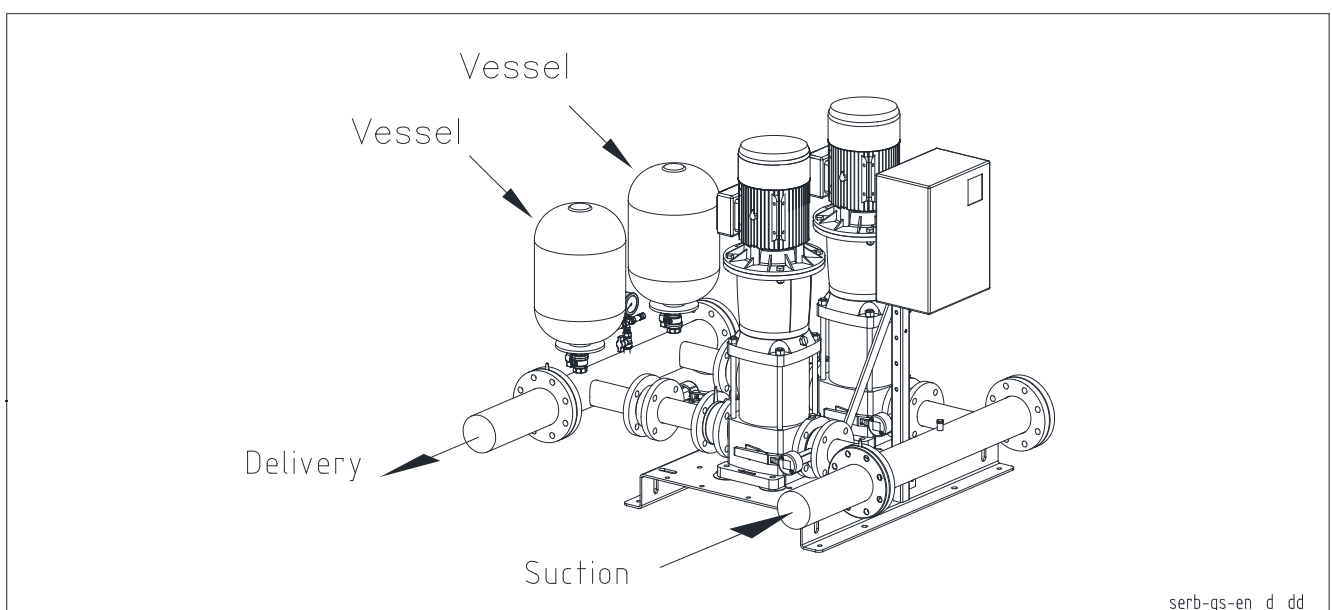

GS BOOSTER SETS SERIES SUCTION CONDITIONS

Installation of the pressure booster set must be assessed especially as regards intake conditions. Intake conditions can negatively or positively affect the performance of the pressure booster unit and consequently system performance.

A positive suction head is ideal for a pressure booster unit as it keeps the electric pumps constantly primed and the positive difference in level adds pressure to the system.

A negative suction head is different. In this case, the risks for the electric pumps are priming which is connected with the intake piping, the NPSH of the electric pump and the difference in level between the electric pump and the water in the tank.

In this type of installation, after checking the intake capacity of the electric pump, the overall pressure drop in the intake line must be calculated as this will reduce electric pump performance and consequently that of the pressure booster unit.

In order to select the right pressure booster unit, the performance levels of the electric pumps installed on them are indicated in this catalogue. To simplify the calculation of net pressure, pressure drop curves, both for the delivery and intake lines of the electric pumps have been included (see the relative chapter).

CHOICE AND SELECTION

The demand of a water distribution system is generally determined by the designer according to the type of user structure being served.

Users can be schools, hospitals, homes, offices, industries, hotels, shopping centres and for each the water demand changes due to the different requirements of the people living and working in these structures.

Integral system calculation, instead, prevents excessive oversizing and therefore reduces running and installation costs.

The theoretical water demand is calculated by summing the demand of each user. As, however, it is improbable that all users will want to use water at the same time, real demand is lower than theoretical demand.

After defining the flow rate of the system, the head must be calculated. This must consider the following:

- geodesic head: difference in level between the electric pumping station and the highest user
- residual head: pressure demand from the most unfavourable user to serve
- pressure drops: value in metres of pressure drops due to friction in the delivery pipes
- inlet height: difference in level between the electric pump inlet and the surface of the water in the tank (positive or negative depending on the installation type)
- inlet pressure drops: value in metres of pressure drops due to friction in the inlet piping and in any curves and valves.

After analysing the above, the head required for the system is calculated.

Now that the flow rate and head values are known, the most suitable pressure booster unit for the system can be chosen. The designer must decide whether to choose a pressure booster unit with two or three electric pumps, the third being a reserve electric pump satisfying demand during electric pump maintenance periods.

GS BOOSTER SETS SERIES SELECTING THE ELECTRIC PUMPS

The choice of electric pump is therefore based on the characteristic curve of the electric pump depending on the flow rate and the pressure required for the system. Starting from the required flow rate, a vertical line is drawn until it meets the horizontal line of the required pressure. The point of intersection of the lines gives both the type and the number of electric pumps necessary for the system.

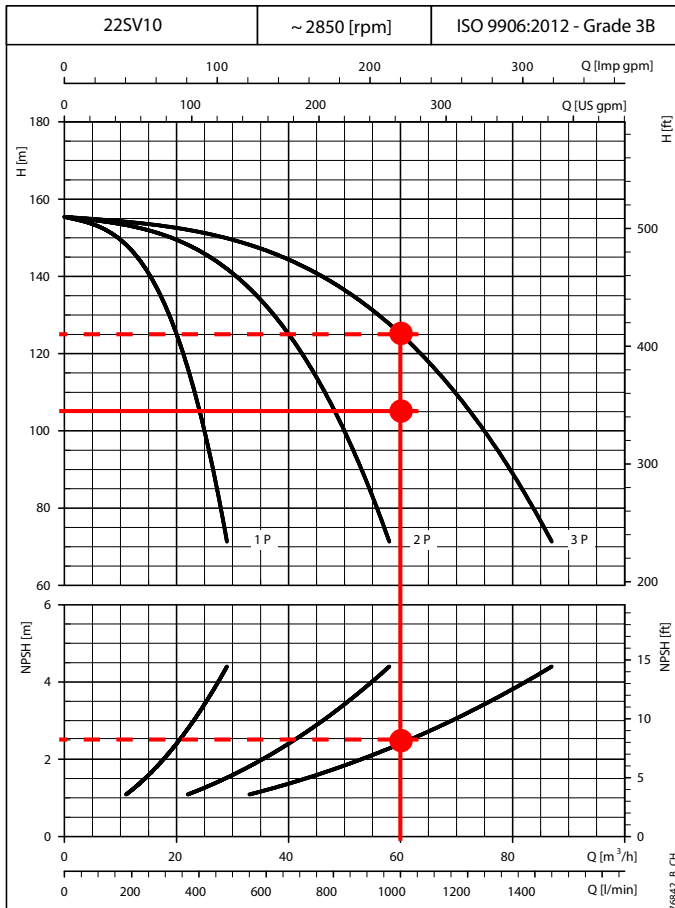

The example alongside refers to a required flow rate of 60 m³/h and a pressure of 105 m water column

As shown in the operating curves on page 73, the selection requires three 22SV10 electric pumps.

Moreover the take-off point falls in the npsH area farthest to the left and therefore in an area with a low cavitation risk.

The values obtained are those for the performance of the electric pumps. A correct check of the net pressure value must be made due to the intrinsic load loss of the booster set and the conditions of installation.

For this reason it is recommended to see the specific chapter in this catalogue.

NPSH

The minimum operating values that can be reached by the electric pump suction are limited by the appearance of cavitation. Cavitation consists in the formation of steam pockets in the liquid when the local pressure reaches a critical value. A critical value is when the local pressure is equal or just below the pressure of the liquid steam. Steam cavitation flows with the current. When it reaches a higher pressure area, condensation of the contained steam occurs. The pockets collide, causing pressure waves that are transmitted to the walls, which are therefore subjected to stress cycles that can cause deformation and then breaks due to fatigue.

This phenomena, characterised by a metallic noise due to the hammering of the walls, is called incipient cavitation. Cavitation damage can be made worse by electrochemical corrosion, and by local temperature increases due to the plastic deformation of the walls. The materials with the highest resistance to heat and corrosion are alloyed steels, and particularly austenitic steels. The conditions that cause cavitation can be predicted by calculating the total suction height, indicated in the technical literature with the acronym NPSH (Net Positive Suction Head). The NPSH represents the total energy (in m) of the flow measured at the suction in incipient cavitation conditions, net of the steam pressure (in m) of the fluid at the input of the electric pump.

GS BOOSTER SETS SERIES SUCTION CONDITIONS

Once the type and the number of electric pumps of the set have been identified, the suction conditions must also be assessed. Below is an example of the assessment of the suction lift installation conditions, in relation to the previously described case:

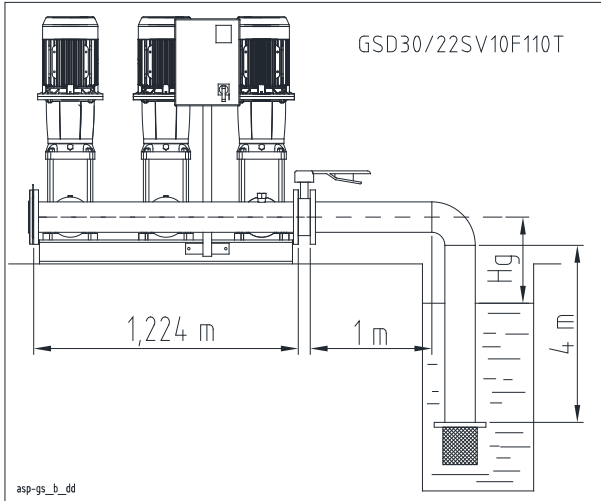

in suction lift installation, it is necessary to calculate the maximum Hg height - which must not be exceeded due to safety reasons -, to avoid cavitation, and therefore the unpriming of the electric pump itself.

The relation that must be assessed, and which connects this value, is the following:

$NPSH_{available} \geq NPSH_{required}$, when the equality condition represents the limit condition.

$$NPSH_{available} = Patm + Hg - \Sigma t - \Sigma a$$

Where:

Patm is the atmospheric pressure, equal to 10,33 m

Hg is the geodetic level difference

Σt are the pressure drops for suction components such as foot check valve, suction piping, curve, gate valve.

Σa are the pressure drops for suction set branch.

L'NPSH_{requested} is a parameter obtained from the performance curve; in our case, at the flow of each electric pump equal to 20 m³/h, it corresponds to 2.5 m (page 73). Before calculating the L'NPSH_{available}, it is necessary to calculate the pressure drops at the suction, using the tables on page 101-102, and taking into account the material, such as the type of stainless steel for the piping and cast iron for the valves.

The total sum of the pressure drops Σt for suction components is made in the following way, considering that the diameter of the suction piping is DN100, equal to the diameter of the suction manifold of the set (page 52).

Calculation of suction drops Σc for cast iron components

Equivalent piping length for DN100 foot check valve = 4,7 m

Equivalent piping length for DN100 gate valve = 0,4 m

Total equivalent length = 4,7 + 0,4 = 5,1 m

Pressure drops in the suction piping (cast iron) $\Sigma c = 5,1 \times 7,79 / 100 = 0,39$ m

Calculation of suction drops Σs for stainless steel components

Equivalent piping length for DN100 90° curve = 2,1 m

Total equivalent length = 2,1 m

Horizontal suction pipe length = 1 m

Vertical suction pipe length = 4 m

Pressure drops in the suction piping (stainless steel) $\Sigma s = (2,1 + 4 + 1) \times 7,79 \times 0,54 / 100 = 0,29$ m

Pressure drops for suction components $\Sigma t = \Sigma c + \Sigma s = 0,39 + 0,29 = 0,68$ m

The total sum of the pressure drops Σt for suction components is made in the following way, considering that the diameter of the suction piping is DN100, equal to the diameter of the suction manifold of the set (page 52).

Hc pressure drops for suction set branch must be assessed on the B curve (pag.90, scheme B0401_A_CH); at the flow value of each electric pump equal to 20 m³/h, a value of Hc = 2,7 m is obtained

Calculation of suction drops Σs for stainless steel components

Equivalent piping length for DN100 manifold T fitting = 4,3 m

Suction manifold length = 1,224 m

Pressure drops in the suction manifold (steel) $\Sigma t = (4,3 + 1,224) \times 7,79 \times 0,54 / 100 = 0,23$ m

Pressure drops $\Sigma a = Hc + \Sigma s = 2,7 + 0,23 = 2,93$ m

Remembering that $NPSH_{available} = Patm + Hg - \Sigma t - \Sigma a$ and that $NPSH_{available} \geq NPSH_{requested}$ we have that

$Patm + Hg - \Sigma t - \Sigma a$ must be $\geq NPSH_{requested}$.

Substituting the values we get that $10,33 + Hg - 0,68 - 2,93 \geq 2,5$ m (NPSH_{requested}),

$Hg = 2,5 + 0,68 + 2,93 - 10,33 = - 4,9$ m, it represents the limit condition for which

NPSH_{available} = NPSH_{requested}

Therefore, in order to guarantee the conditions for the correct operation of the system as far as cavitation risks, it will be necessary to position the electric pump above the water level, **so that the Hg height is below the limit value of 4,9 m.**

GS BOOSTER SETS SERIES NET PRESSURE CALCULATION

When selecting GS booster sets, the performance levels of the electric pump must be taken into account. Performance levels are obtained from the characteristic curves of the electric pumps, and do not take into account any pressure drops due to system piping and valves. The following example helps the customer to obtain the correct delivery manifold pressure value: by knowing the system operating point $Q = 60 \text{ m}^3/\text{h}$ and $H = 105 \text{ mca}$ (P requested), and the installation height H_g (estimated to 5 m), in order to make the calculations easier we use the pressure drop curves for each single electric pump on page 90 of this catalogue.

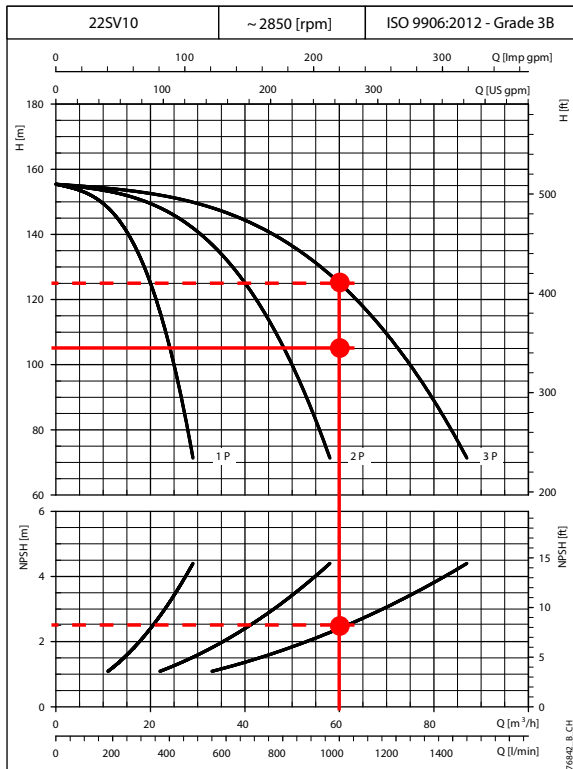

Assuming that a booster set GHV30/22SV with non-return valves on the delivery has been selected, we proceed as follows:

$P_{\text{net available}} \geq P_{\text{requested}}$, when the equality condition represents the limit condition.

$P_{\text{net available}} = H - (H_g + \sum t + \sum a + \sum m)$

Where:

- H head value of booster set
- H_g is the geodetic level difference (estimated to 5 m)
- $\sum t$ are the pressure drops for suction components such as foot check valve, suction piping, curve and gate valve.
- $\sum a$ are the pressure drops for suction set branch
- $\sum m$ are the pressure drops for delivery set branch

The total sum of the pressure drops $\sum t$ for suction components is made in the following way, considering that the diameter of the suction piping is DN100, equal to the diameter of the suction manifold of the set (page 52).

Calculation of suction drops $\sum c$ for cast iron components

Equivalent piping length for DN100 foot check valve = 4,7 m

Equivalent piping length for DN100 gate valve = 0,4 m

Total equivalent length = 4,7 + 0,4 = 5,1 m

Pressure drops in the suction piping (cast iron) $\sum c = 5,1 \times 7,79 / 100 = 0,39 \text{ m}$

Calculation of suction drops $\sum s$ for stainless steel components

Equivalent piping length for DN100 90° curve = 2,1 m

Total equivalent length = 2,1 m

Horizontal suction pipe length = 1 m

Vertical suction pipe length = 4 m

Pressure drops in the suction piping (stainless steel) $\sum s = (2,1 + 4 + 1) \times 7,79 \times 0,54 / 100 = 0,29 \text{ m}$

Pressure drops for suction components $\sum t = \sum c + \sum s = 0,39 + 0,29 = 0,68 \text{ m}$

The total sum of the pressure drops $\sum t$ for suction components is made in the following way, considering that the diameter of the suction piping is DN100, equal to the diameter of the suction manifold of the set (page 52).

H_c pressure drops for suction set branch must be assessed on the B curve (pag.90, scheme B0401_A_CH);

at the flow value of each electric pump equal to 20 m³/h, a value of $H_c = 2,7 \text{ m}$ is obtained

GS BOOSTER SETS SERIES NET PRESSURE CALCULATION

Calculation of suction drops $\sum s$ for stainless steel components

Equivalent piping length for DN100 manifold T fitting = 4,3 m

Suction manifold length = 1,224 m

Pressure drops in the suction manifold (steel) $\sum t = (4,3 + 1,224) \times 7,79 \times 0,54 / 100 = 0,23$ m

Pressure drops $\sum a = H_c + \sum s = 2,7 + 0,23 = 2,93$ m

The total sum of the pressure drops $\sum m$ for delivery branch is made in the following way, considering that the diameter of the delivery manifold is DN100, equal to the diameter of the delivery manifold of the set (page 52). H_c pressure drops for delivery set branch must be assessed on the A curve (pag.90, scheme B0401_A_CH); at the flow value of each electric pump equal to 20 m³/h, a value of $H_c = 0,0034$ m is obtained

Calculation of delivery drops $\sum s$ for stainless steel components

Equivalent piping length for DN100 manifold TEE fitting = 4,3 m

Delivery manifold length = 1,224 m

Pressure drops in the delivery manifold (steel) $\sum s = (4,3 + 1,224) \times 7,79 \times 0,54 / 100 = 0,23$ m

Pressure drops in delivery manifold $\sum m = H_c + \sum s = 0,0034 + 0,23 = 0,2334$ m

If we analyse the performance of the set at the flow value of 60 m³/h, the head value H is 125 m.

The net pressure at the delivery manifold will be $P_{\text{net available}} = H - (H_g + \sum t + \sum a + \sum m)$

Substituting the values we get that $P_{\text{net available}} = 125 - (5 + 0,68 + 2,93 + 0,2334) = 123,84$ m

When comparing this value with the design value (not taking into account the dynamic energy) we see that $123,84 \text{ m} > 105 \text{ m}$ [$P_{\text{net available}} > P_{\text{required}}$]

The set is therefore capable of meeting system requirements.

GS20, GS30 SERIES

Fixed speed booster sets

e-SV series multistage vertical electric pumps

Electrical motor power up to 37 kW

Flow rates up to 480 m³/h and pressures up to 16 bar

GS BOOSTER SETS SERIES IDENTIFICATION CODE

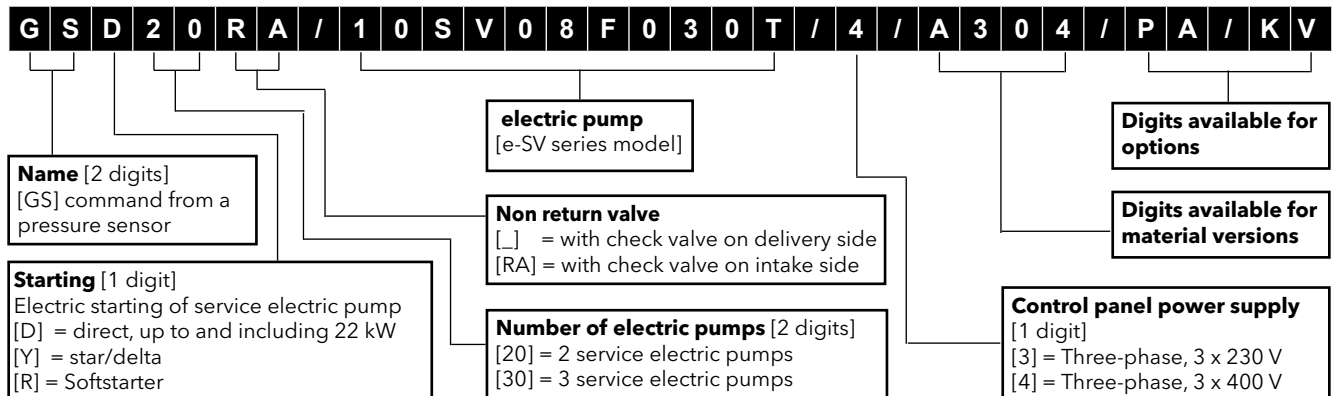

MATERIAL VERSIONS

- A304 Main components in contact with the liquid in AISI 304 stainless steel or higher. Galvanised screws and bolts. Flanges not in contact with the liquid galvanised.
- B304 Main components in contact with the liquid in AISI 304 stainless steel or higher. Screws and bolts in AISI 304 stainless steel or higher. Flanges not in contact with the liquid in AISI 304 stainless steel.
- C304 Main components in contact with the liquid in AISI 304 stainless steel or higher. Base, brackets, supports, screws and bolts in AISI 304 stainless steel or higher. Flanges not in contact with the liquid in AISI 304 stainless steel or higher. Valves fully made of AISI 304 stainless steel or higher (body, heads, disc).
- A316 Main components in contact with the liquid in AISI 316 stainless steel or higher. Galvanised screws and bolts. Flanges not in contact with the liquid galvanised.
- B316 Main components in contact with the liquid in AISI 316 stainless steel. Screws and bolts in AISI 316 stainless steel. Flanges not in contact with the liquid in AISI 316 stainless steel.
- C316 Main components in contact with the liquid in AISI 316 stainless steel. Base, brackets, supports, screws and bolts in AISI 316 stainless steel. Flanges not in contact with the liquid in AISI 316 stainless steel. Valves fully made of AISI 316 stainless steel (body, heads, disc).

OPTIONS

- 3A Booster set with electric pump certified 1A (Factory test reports includes QH curve).
- 3B Booster set with electric pump certified 1B (Test report includes QH curve, efficiency and power).
- 60 60 Hz frequency voltage supply for booster.
- BAP High pressure switch mounted on delivery manifold.
- C9 Turned up discharge manifold, elbow, no membrane vessel on discharge manifold.
- CI Control panel with engines isolation control.
- CM Suction manifold or delivery manifold oversized.
- CP Dry contacts: power, automatic/manual, run/stop for each electric pump, thermal overload, low level alarm, minimum/maximum pressure alarm, external alarm.
- DR1 Booster set with 1 optical level switch for the control of the liquid presence/absence, fixed on to suction manifold; set with special control panel.
- FY Y filters placed on suction of each electric pump.
- IP65 Control panel IP65.
- PA Minimum pressure switch mounted on suction manifold and connected to lack of water input.
- PE Emergency shut-off pushbutton.
- PMA Vacuum pressure gauge and minimum pressure switch connected to lack of water input, both mounted on suction manifold.
- PP Booster with pressure switch instead pressure transmitters.
- PQ Booster set with high suction pressure (pressure gauge/pressure switches/pressure transmitter increased of one range)
- RE Heaters inside the control panel, with thermostat.
- RV Control panel with phase sequence, phase loss, over- and undervoltage and phase unbalance.
- SA Without suction: without valves on suction and without suction manifold.
- SC Booster set without pressure switches or transmitter, pressure gauge is mounted.
- SCA Without suction manifold (valves are mounted).
- SCM Without delivery manifold (without pressure switches, transmitter and pressure gauge, valves are mounted).
- SM Without delivery: without valves on delivery and without delivery manifold.
- SQ Without control panel and without panel frame, switches or transmitters are present.
- SQC Without control panel and without panel frame, switches or transmitters aren't present.
- SR Without non return valve.
- TS Booster set with electric pumps equipped with special mechanical seals.
- VA Control panel with digital voltmeter and ammeter.
- WM Control panel wall mounting version. Cable length 5 m

Some options are not feasible concurrently. Please contact the Sales and Technical Assistance Service.

GS BOOSTER SETS SERIES RANGE

The standard range of GS series fixed-speed booster sets includes models with 2 and 3 electric pumps in different configurations, to adapt to the specific needs of each application.

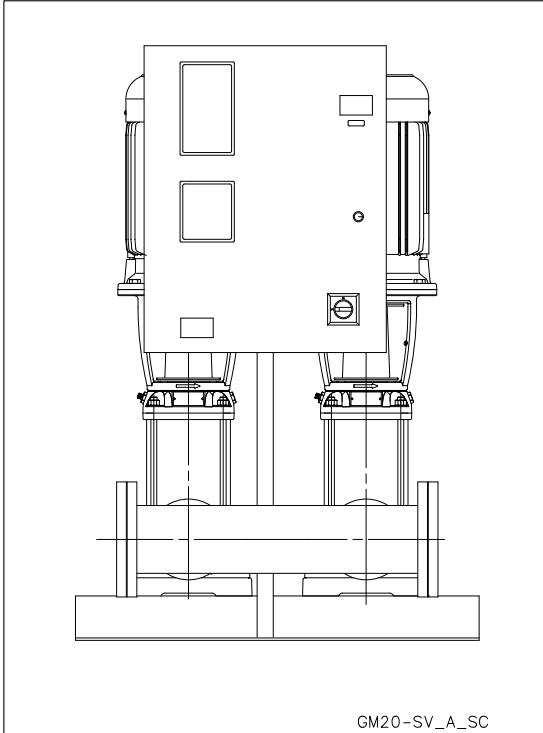

GS20 SETS

Fixed-speed sets with two multistage vertical service electric pumps, SV series, with power ratings up to 37 kW.

Head up to 160m.
Flow rate up to 320 m³/h.

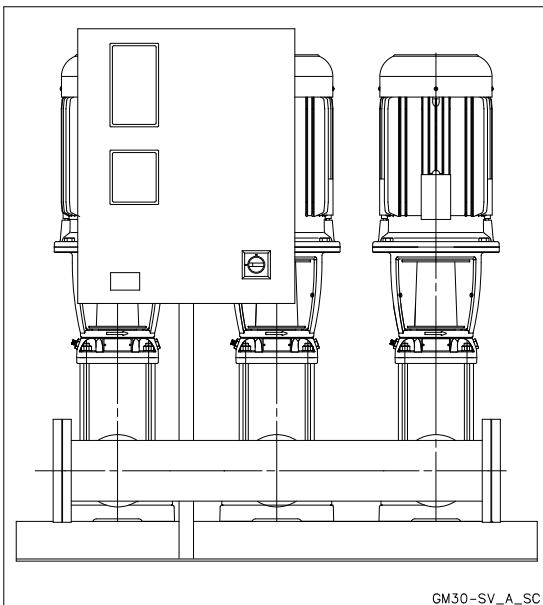

GS30 SETS

Fixed-speed sets with three multistage vertical service electric pumps, SV series, with power ratings up to 37 kW.

Head up to 160m.
Flow rate up to 480 m³/h.

ELECTRIC PUMPS GENERAL DESCRIPTION

The **e-SV** electric pump is a multistage vertical electric pump, not self-priming, combined with a normalised standard motor.

The liquid end, located between the upper cover and the electric pump casing, is held in place by tie rods. The electric pump casing is available with different configurations and connection types.

Technical Information:

Flow rates: up to 160 m³/h.

Heads: up to 160 m.

(referred to the electric pump range used in this catalogue).

Temperature of electric pumped liquid:
from -30°C to +120°C (standard version).

Tested to ISO 9906:2012 - Grade 3B
(ex ISO 9906:1999 - annex A).

Direction of rotation: clockwise looking at the electric pump from the top down (indicated with an arrow on the bracket and joint).

Mechanical seal: Silicon carbide/Carbon/EPDM.
e-SV electric pumps (only for 10, 15, 22SV ≥ 5,5 kW and 33, 46, 66, 92, 125SV) are fitted standard with a balanced mechanical seal that can be replaced without having to remove the motor from the electric pump.

Elastomers: EPDM.



Motor

Supplied IE3 three-phase surface motors ≥ 0,75 kW as standard.

Electrical performances according to EN 60034-1.

Insulation class 155 (F).

IP55 protection.

Condensate drain plugs on standard version.

Cooling by fan according to EN 60034-6.

Cable gland metric size according to EN 50262.

Standard supplied e-SV electric pumps are equipped with Standard motors.

Standard voltage:

- **Three-phase version:** 220-240/380-415 V or 380-415/660-690 V 50 Hz.

For electrical data of the motors used see page 18 and 19.

Materials

The electric pumps for F, T, R, N, G versions are certified for drinking water use (**WRAS** and **ACS** certified).

For complete information see dedicated e-SV technical catalogue.

ELECTRIC PUMPS 3, 5, 10, 15, 22SV SERIES CHARACTERISTICS

- Multistage centrifugal vertical electric pumps. All metal parts in contact with electric pumped liquid are made of stainless steel.
- **F** version: round flanges, in-line delivery and suction ports, AISI 304 stainless steel.
- Further choice possibilities among the following versions:
 - **T**: oval flanges, in-line delivery and suction ports, AISI 304 stainless steel.
 - **R**: round flanges, delivery port above the suction port and adjustable in four positions, AISI 304 stainless steel.
 - **N**: round flanges, in-line delivery and suction ports, AISI 316 stainless steel.
- Reduced axial thrusts enable the use of **standard motors** that are easily found on the market.
- Standard mechanical seal according to EN 12756 (formerly DIN 24960) and ISO 3069 for series 1, 3, 5SV and 10, 15, 22SV (\leq di 4 kW).
- **Balanced mechanical seal** according to EN 12756 (formerly DIN 24960) and ISO 3069, easy to replace **without removing the electric pump motor**, for series 10, 15 and 22SV (\geq di 5,5 kW).
- Seal housing designed to avoid air accumulation inside the critical area adjoining the mechanical seal.
- Second loading plug available for series 10, 15, 22SV.
- Easy maintenance. No special tools required for assembly or disassembly.

F, T, R and N electric pumps are certified for use with drinking water (WRAS and ACS)

33, 46, 66, 92, 125SV SERIES CHARACTERISTICS

- Version **G**: Multistage vertical centrifugal electric pump with impellers, diffusers and outer jacket fully made of stainless steel; superior cast iron electric pump body and head. Round flanges, in-line delivery and suction ports.
- Further choice possibilities among the following versions:
 - **N, P**: fully made of AISI 316 stainless steel.
- In electric pumps with higher heads, the axial load compensation system allows a reduction of axial thrusts, and therefore the use of **normalised standard motors**, easy to find on the market.
- **Balanced mechanical seal** according to EN 12756 (formerly DIN 24960) and ISO 3069, **easy to replace without removing the electric pump motor**.
- Seal housing designed to avoid air accumulation inside the critical area adjoining the mechanical seal.
- Electric pump body supplied with the necessary attachments for a pressure gauge on the flanges, both on the suction and the delivery side.
- Mechanical strength and easy maintenance. No special tools required for assembly or disassembly.

G and N electric pumps are certified for use with drinking water (WRAS and ACS)

ELECTRIC PUMPS THREE-PHASE MOTORS AT 50 Hz, 2-POLE (up to 22 kW)

P _N kW	Efficiency η_N %																		Year of manufacture				
	Δ 220 V Y 380 V			Δ 230 V Y 400 V			Δ 240 V Y 415 V			Δ 380 V Y 660 V			Δ 400 V Y 690 V			Δ 415 V				IE			
	4/4	3/4	2/4	4/4	3/4	2/4	4/4	3/4	2/4	4/4	3/4	2/4	4/4	3/4	2/4	4/4	3/4	2/4					
0,37	-	-	-	-	-	-	-	-	-	-	-	-	-	-	-	-	-	-	-	-	-	3	From 11/2014
0,55	-	-	-	-	-	-	-	-	-	-	-	-	-	-	-	-	-	-	-	-	-		
0,75	82,5	83,1	81,3	82,8	82,7	80,1	82,6	82,0	78,9	82,5	82,0	78,9	82,5	82,0	78,9	82,5	82,0	78,9	-	-	-		
1,1	84,0	84,7	83,4	84,4	84,5	82,5	84,3	84,0	81,4	84,0	84,0	81,4	84,0	84,0	81,4	84,0	84,0	81,4	-	-	-		
1,5	85,6	86,5	85,8	85,9	86,4	84,9	86,0	86,0	84,0	85,6	86,0	84,0	85,6	86,0	84,0	85,6	86,0	84,0	-	-	-		
2,2	86,5	87,4	86,8	86,4	86,9	85,7	86,6	86,7	85,0	86,4	86,7	85,0	86,4	86,7	85,0	86,4	86,7	85,0	-	-	-		
3	87,2	88,5	88,3	87,5	88,2	87,5	87,5	87,8	86,4	87,2	87,8	86,4	87,2	87,8	86,4	87,2	87,8	86,4	-	-	-		
4	89,1	90,1	89,2	89,1	90,1	89,2	89,1	90,1	89,2	89,1	90,3	90,4	89,6	90,4	89,9	89,6	90,1	89,2	-	-	-		
5,5	89,5	89,6	88,0	89,5	89,6	88,0	89,5	89,6	88,0	89,5	90,3	89,9	89,7	90,0	89,0	89,6	89,6	88,0	-	-	-		
7,5	90,6	90,5	89,0	90,6	90,5	89,0	90,6	90,5	89,0	90,6	91,0	90,2	90,8	90,8	89,6	90,7	90,5	89,0	-	-	-		
11	91,3	92,0	91,1	91,3	92,0	91,1	91,3	92,0	91,1	91,3	92,2	92,2	91,6	92,2	91,7	91,7	92,0	91,1	-	-	-		
15	92,5	92,4	91,2	92,5	92,4	91,2	92,5	92,4	91,2	92,7	93,3	92,9	93,1	93,3	92,7	92,5	92,4	91,2	-	-	-		
18,5	92,6	93,1	92,4	92,6	93,1	92,4	92,6	93,1	92,4	92,6	93,2	93,0	92,9	93,3	92,8	92,9	93,1	92,4	-	-	-		
22	93,0	92,7	91,3	93,0	92,7	91,3	93,0	92,7	91,3	93,0	93,2	92,4	93,1	93,0	91,9	93,0	92,7	91,3	-	-	-		

P _N kW	Manufacturer		IEC SIZE*	Construction Design	N. of Poles	f _N Hz	Data for 400 V / 50 Hz Voltage				
	Xylem Service Italia Srl Reg. No. 07520560967 Montecchio Maggiore Vicenza - Italia						cos ϕ	I _s / I _N	T _N Nm	T _s /T _N	T _m /T _N
	Model										
0,37	SM71RB14/304		71R	V18/B14	2	50	0,64	4,35	1,37	4,14	4,10
0,55	SM71B14/305		71				0,74	5,97	1,85	3,74	3,56
0,75	SM80B14/307 PE		80				0,78	7,38	2,48	3,57	3,75
1,1	SM80B14/311 PE		80				0,79	8,31	3,63	3,95	3,95
1,5	SM90RB14/315 PE		90R				0,80	8,80	4,96	4,31	4,10
2,2	PLM90B14/322 E3		90				0,80	8,77	7,28	3,72	3,70
3	PLM100RB14/330 E3		100R				0,79	7,81	9,93	4,26	3,94
4	PLM112RB14S6/340 E3		112R				0,85	9,13	13,2	3,82	4,32
5,5	PLM132RB5/355 E3		132R				0,85	10,5	18,1	4,74	5,11
7,5	PLM132B5/375 E3		132				0,85	10,2	24,4	3,43	4,76
11	PLM160RB5/3110 E3		160R				0,86	9,89	35,9	3,46	4,59
15	PLM160B5/3150 E3		160				0,88	9,51	48,6	2,73	4,32
18,5	PLM160B5/3185 E3		160				0,88	9,81	59,9	2,81	4,53
22	PLM180RB5/3220 E3		180R				0,85	10,9	71,1	3,26	5,12

P _N kW	Voltage U _N V										n _N min ⁻¹	Observe the regulations and codes locally in force regarding sorted waste disposal.	Operating conditions **			
	Δ			Y			Δ			Y			Altitude Above Sea Level (m)	T. amb min/max °C	ATEX	
	220 V	230 V	240 V	380 V	400 V	415 V	380 V	400 V	415 V	660 V						690 V
0,37	2,03	2,18	2,32	1,17	1,26	1,34	-	-	-	-	-	2745 ÷ 2800	≤ 1000	-15 / 40	No	
0,55	2,56	2,56	2,62	1,48	1,48	1,51	-	-	-	-	-	2825 ÷ 2850				
0,75	2,96	2,94	2,96	1,71	1,70	1,71	1,70	1,69	1,70	0,98	0,98	2875 ÷ 2895				
1,1	4,19	4,14	4,16	2,42	2,39	2,40	2,41	2,38	2,38	1,39	1,37	2870 ÷ 2900				
1,5	5,56	5,49	5,51	3,21	3,17	3,18	3,21	3,18	3,19	1,85	1,84	2870 ÷ 2895				
2,2	7,97	7,90	7,98	4,6	4,56	4,61	4,57	4,54	4,57	2,64	2,62	2880 ÷ 2900				
3	11,0	11,0	11,2	6,35	6,33	6,44	6,29	6,27	6,34	3,63	3,62	2865 ÷ 2895				
4	13,6	13,4	13,4	7,87	7,75	7,74	7,80	7,62	7,61	4,50	4,40	2885 ÷ 2910				
5,5	18,1	17,9	18,1	10,4	10,4	10,4	10,6	10,5	10,7	6,10	6,05	2880 ÷ 2910				
7,5	24,8	24,4	24,3	14,3	14,1	14,0	14,4	14,1	14,2	8,32	8,16	2920 ÷ 2935				
11	35,7	35,0	34,9	20,6	20,2	20,2	20,6	20,2	20,2	11,9	11,7	2910 ÷ 2930				
15	47,6	46,1	45,2	27,5	26,6	26,1	27,5	26,6	26,1	15,9	15,3	2940 ÷ 2950				
18,5	58,3	56,7	55,6	33,7	32,7	32,1	34,0	33,0	32,7	19,6	19,0	2940 ÷ 2950				
22	72,9	73,1	73,7	42,1	42,2	42,6	40,9	40,4	40,6	23,6	23,3	2950 ÷ 2960				

* R = Reduced size of motor casing as compared to shaft extension and flange.

** Operating conditions to be referred to motor only. About electric pump, refer to limits in user's manual.

ELECTRIC PUMPS THREE-PHASE MOTORS AT 50 Hz, 2-POLE (from 30 to 55 kW)

P _N kW	Efficiency η_N %									IE	Year of manufacture
	Δ 380 V Y 660 V			Δ 400 V Y 690 V			Δ 415 V				
	4/4	3/4	2/4	4/4	3/4	2/4	4/4	3/4	2/4		
30	93,0	93,1	93,0	93,3	93,5	93,4	93,4	93,6	93,4	3	From 04/2020
37	93,5	94,0	93,7	93,7	94,1	93,8	93,8	94,2	93,9		
45	93,8	94,0	93,5	94,0	94,2	93,6	94,2	94,4	93,8		
55	93,8	94,0	93,9	94,3	94,6	94,5	94,4	94,7	94,5		

P _N kW	Manufacturer	IEC SIZE	Construction Design	N. of Poles	f _N Hz	Data for 400 V / 50 Hz Voltage				
	OMEGA MOTOR SANAYI A.S. Dudullu Organize Sanayi Bölgesi 2. Cadde No: 10 34775 Ümraniye ISTANBUL/TURKEY					cos ϕ	Is / I _N	T _N Nm	Ts/T _N	Tm/T _N
30	Model 3MAS 200LA2 V1 30KW E3	200	V1	2	50	0,89	7,80	96,90	2,60	3,10
37	3MAS 200LB2 V1 37KW	200				0,90	8,00	119,4	2,90	3,20
45	3MAS 225M2 V1 45KW E3	225				0,91	8,20	144,4	2,70	3,30
55	3MGS 250M2 V1 55KW E3	250				0,90	7,60	176,4	2,50	3,00

P _N kW	Voltage U _N V					n _N min ⁻¹	See note.	Operating conditions **		
	Δ			Y				Altitude Above Sea Level (m)	T. amb min/max °C	ATEX
	380 V	400 V	415 V	660 V	690 V					
30	55,3	52,2	50,8	31,8	30,3	2965	≤ 1000	-15 / 50	No	
37	66,6	63,9	61,5	38,4	37,0	2965				
45	80,6	75,9	73,7	46,4	44,0	2975				
55	98,2	92,7	89,7	56,5	53,7	2975				

** Operating conditions to be referred to motor only. About electric pump, refer to limits in user's manual.

sv-IE3-mott55-2p50-en_b_te

Note: Observe the regulations and codes locally in force regarding sorted waste disposal.

SOUND EMISSION LEVELS

50 Hz 2900 rpm		LpA (dB \pm 2)**	
P2 (kW)	IEC*	G..20	G..30
0,37	71R	-	-
0,55	71	-	-
0,75	80R	-	-
1,1	80	<70	<70
1,5	90R	<70	<70
2,2	90	<70	<70
3	100R	<70	<70
4	112R	<70	<70
5,5	132R	<70	<70
7,5	132	74	76
11	160R	76	78
15	160	74	76
18,5	160	76	78
22	180R	73	75
30	200	71	73
37	200	71	73

* R=Reduced motor casing size with respect to shaft extension and related flange.

gsfix_2p-en_d_tr

** Noise value of the electric motor only.

ELECTRIC PUMPS WORKING LIMITS

Liquids handled	Water containing no gas or corrosive and/or aggressive substances.
Fluid temperature	Above -10°C a + 80 °C
Ambient temperature	Above 0°C a + 40 °C
Maximum operating pressure	Max 8 bar, 10 bar, 16 bar in function of pump type
Minimum inlet pressure	According to NPSH curve and losses, with a minimum margin of 0.5 m
Maximum inlet pressure	The inlet pressure added to the pressure of the pump at zero flow must be lower than the maximum operating pressure of the set.
Installation	Indoors, protected from the weather. Away from heat sources. Max elevation 1000 m ASL. Max humidity 50% without condensation.
Hourly starts (single pump)	0,25 kW ≤ Pn ≤ 3 kW max 60 starts per hour. Direct motor start; 4 kW ≤ Pn ≤ kW max 40 starts per hour. Direct motor start; 11 kW ≤ Pn ≤ kW max 30 starts per hour. Direct motor start; 18,5 kW ≤ Pn ≤ 22 kW max 24 starts per hour. Direct motor start; 30 kW ≤ Pn ≤ 37 kW max 16 starts per hour. Start/delta start; Pn = 45 kW max 8 starts per hour. Start/delta start;
Sound emission	See table

* On request, PN above in function of the pump

gfix_2p-en_c_ti

GS BOOSTER SETS SERIES CONTROL PANEL FOR GS20, GS30

Electric panel for powering, controlling and protecting two or three electric pumps, protected to IP55, metal case. IP65 protection grade is an option (GS../IP65).

Main characteristics:

- General doorlock switch, fuse holders and fuses, starting contactors and circuit breakers.
- Standard input voltage: 3x400Vac +/-10%, 50/60Hz. Non-standard voltages available on request, 1x230Vac +/-10%, 3x230ca +/-10%, 50/60Hz.
- Transformer for auxiliary low voltage circuit; auxiliary voltage 24Vac.
- SM30 digital microprocessor-controlled control unit with LCD display and programming keyboard (see fig. 2), featuring the following functions:

- Indicator lamps: power on (ref.1), general fault (ref.2), no water alarm (ref.3), electric pump running (ref.4);

- Programming keyboard (ref.5);

- Manual electric pump stop/start (one button for each electric pump) (ref.5);

- Automatic cascade electric pump control with two electronic pressure transmitters. If a sensor develops a fault, the board automatically switches to the second sensor. Pressure switch control available on request.

- Jockey electric pump management on request.

- Cycle reversal function (can be disabled). Automatically switches electric pumps after every start/stop cycle.

- Automatic, manual or disabled mode switches for each pump (inside the board).

- Periodic system self-test with an electrovalve command which opens the hydraulic circuit, simulates a pressure drop and consequently activates the control devices (pressure switches and pressure transmitters). electric pump diagnostics.

- No-water protection system alternatives: float, minimum pressure switch, external contact or electrode probes with sensitivity adjustment.

- Adjustable timer delaying tripping the no-water protection system.

- Adjustable timer delaying starting of each electric pump.

- Adjustable timer extending the operation of each electric pump.

- System pressure drop offset function, only available with pressure sensor.

- Adjustable analogue output, 0(4)-20mA or 0-2(10)Vdc, for visualising the analogue input signal.

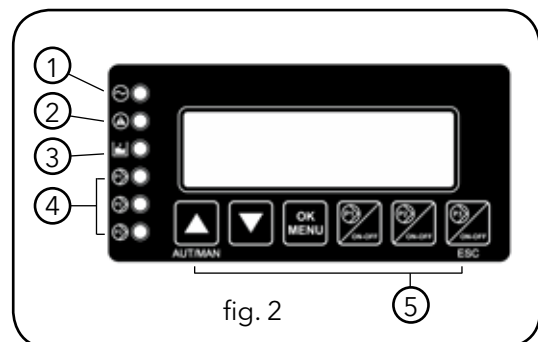
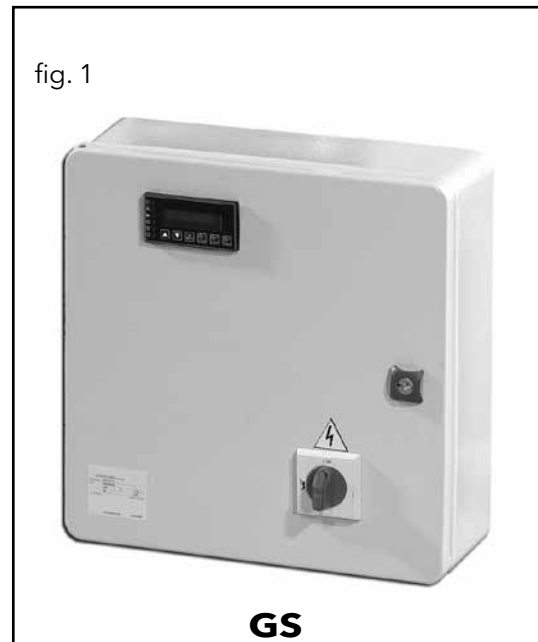

GS BOOSTER SETS SERIES CONTROL PANEL FOR GS20, GS30

- Configurable relay with volt-free contact, delayed activation, signalling the following conditions:
 - Motor overload protection alarm.
 - No-water circuit alarm.
 - Pressure sensor fault.
 - Out-of-curve operation alarms (only if self-test is disabled).
 - Maximum intake pressure alarm.
 - Electrovalve opening permission for self-test circuit.
- Configurable digital inputs.
 - AUX1 input configuration, maximum pressure switch or external self-test.
 - AUX2 input configuration, permission from external device (NO) or external alarm (NC).
 - AUX3 input configuration, change set (NO) or pressure switch operating out-of-curve.
- 12Vdc output for powering the acoustic alarm.
- Alarms log and hour counters for each installed electric pump. Alarms visualised on display:
 - Maximum, minimum pressure;
 - Circuit breaker for each motor;
 - Pressure transmitter fault.
 - Out-of-curve operation;
 - No water;
 - Block for tripped external device (e.g overvoltage/undervoltage, or thermal overload, etc.)
 - Auto-test failedAll the alarms light the Fault lamp (ref.2 - fig.2)
The no-water alarm lights the Level alarm lamp (ref.3 - fig.2)
- Standard, RS485 serial communication, slave, and ModBus RTU protocol.
- A relay board (optional) can be connected to boost the following signals: electric pump running, aut-man mode for each electric pump, overload alarm, no-water alarm, maximum/minimum pressure alarm, power on, self-test failed. The optional signal booster board has six relays, each of which can be configured using the SM30 control unit.

For booster sets requiring a wall mounted control panel (GS.../WM), the panel is supplied with 5 metre cables.

Other options available:

- GS.../CP
- GS.../PA
- GS.../60

See the option description on page 14.

GS BOOSTER SETS SERIES MAIN COMPONENTS

- **Main On-off valves** on suction and discharge side of each electric pump, ball type with threaded coupling up to 2" size included. Butterfly type for installation between the flanges are used for larger diameters.
- **Check valve** on discharge side of each electric pump, spring-loaded type, with threaded coupling up to 2" size, as well as the double-swing type to fit between the flanges.
- **Suction manifold** with threaded or flanged ends depending on the type of electric pump (see drawings). Threaded coupling for water charging.
- **Delivery manifold** with threaded or flanged ends depending on the type of electric pump (see drawings). Fitted with two R1" threaded couplings with caps to allow connection of diaphragm pressure vessels.
- **Pressure gauge and 2 control transmitters** located on the delivery manifold of the unit.
- **Electric control panel**, IP55 protection class.
- **Various couplings** for the connections.
- **Mounting base**, for electric pumpset and panel mounting brackets.
- **Anti-vibration dampers** sized depending on the set. In some sets they are provided but not assembled. The installation is the responsibility of the customer.

VERSIONS AVAILABLE

Manifolds, valves, flanges, base and main components made of AISI 304 or AISI 316 stainless steel; versions:

GHV.../A304, GHV.../B304, GHV.../C304,
GHV.../A316, GHV.../B316, GHV.../C316

Accessories on request:

- Devices for **protection against dry running** in one of the following versions:
 - float switch;
 - pack of electronic module and probe electrodes;
 - minimum pressure switch.
- **Diaphragm expansion vessel kit**
Hydrotube with on-off valve, depending on the maximum head of the electric pump::
 - 24 lt, 8 bar hydro tube kit
 - 24 lt, 10 bar hydro tube kit
 - 24 lt, 16 bar hydro tube kit
 - 20 lt, 25 bar hydro tube kit

SPECIAL VERSIONS AVAILABLE ON REQUEST (Contact the Sales and technical Assistance Service)

- Units with non-standard input voltages, such as three-phase 3x230V, 3x440V.
- Units with single-phase input voltages 1x230V.
- Units with 4-5 service electric pumps (GS40...GS50...).
- Units with 2-3-4 service electric pumps and jockey electric pump (GS21... GS31... GS41...).
- Units with stainless steel expansion vessels.
- Units with special valves.

GS BOOSTER SETS SERIES TABLE OF MATERIALS FOR SETS WITH 10-15-22SV ELECTRIC PUMPS

DENOMINATION	G... (STANDARD)	G.../A304	G.../A316
Manifolds	AISI 304	AISI 304	AISI 316
On-off valves	Nickel-plated brass	AISI 316	AISI 316
Non-return valves	Brass	AISI 304	AISI 316
Pressure switches	Galvanized steel/AISI 301	AISI 301	AISI 301
Pressure transmitters	AISI 304	AISI 304	AISI 304
Caps/plugs	AISI 304 / 316	AISI 304 / 316	AISI 316
Sliding/Blind Flanges (not in contact with liquid)	Galvanized steel	Galvanized steel *	Galvanized steel *
Welded flanges (contact with liquid)	AISI 304	AISI 304	AISI 316
Fittings	AISI 316	AISI 316	AISI 316
Bracket	Galvanized steel/painted steel	Galvanized steel/painted steel	Galvanized steel/painted steel
Base	Painted steel	Painted steel	Painted steel

* B304, C304 version in AISI 304; B316, C316 version in AISI 316

g_wad_3-22sv-en_b_tm

TABLE OF MATERIALS FOR SETS WITH 33-46-66-92-125SV ELECTRIC PUMPS

DENOMINATION	G... (STANDARD)	G.../A304	G.../A316
Manifolds	AISI 304	AISI 304	AISI 316
On-off valves (disc)	Epoxy	AISI 316	AISI 316
Non-return valves	Painted cast iron with stainless steel flaps	AISI 304	AISI 316
Pressure switches	Galvanized steel/AISI 301	AISI 301	AISI 301
Pressure transmitters	AISI 316	AISI 316	AISI 316
Caps/plugs	AISI 304 / 316	AISI 316	AISI 316
Sliding/Blind Flanges (not in contact with liquid)	Galvanized steel	Galvanized steel *	Galvanized steel *
Welded flanges (contact with liquid)	AISI 304	AISI 304	AISI 316
Fittings	AISI 316	AISI 316	AISI 316
Bracket	Painted steel	Painted steel	Painted steel
Base	Painted steel	Painted steel	Painted steel

* B304, C304 version in AISI 304; B316, C316 version in AISI 316

g_wad_33-125sv-en_d_tm

WORKING LIMITS

The input pressure of the electric pump, added to the pressure with the port shut off, must not exceed the maximum permitted operating pressure (PN) of the set.

Permitted liquids	Water without gases and corrosive and/or aggressive substances.
Fluid temperature	-10°C to + 80 °C
Ambient temperature	0°C to + 40 °C
Maximum operating pressure*	Max 16 bar
Minimum input pressure	In line with the NPSH curve and the losses, with a margin of at least 0,5 m
Maximum input pressure	The input pressure added to the pump pressure without flow must be lower than the maximum operating pressure of the set.
Installation	Internal environment protected from atmospheric agents. Away from heat sources. Max altitude 1000 a.s.l. Max humidity 50%, without condensation.
Sound emission	See table

* Higher PN available on request depending on pump type

ghvl_2p-en_a_ti

GS20/10SV BOOSTER SETS SERIES HYDRAULIC PERFORMANCE TABLE AT 50 HZ (SERVICE)

PUMP TYPE	RATED POWER kW	MEI ≥ (1)	Q = DELIVERY													
			l/min 0	166,7	200	266	340	366,7	466	540	660	700	800	860	920	966,7
			m ³ /h 0	10,0	12,0	16,0	20,4	22,0	28,0	32,4	39,6	42,0	48,0	51,6	55,2	58,0
H = TOTAL HEAD IN METRES OF COLUMN OF WATER																
10SV09	2 x 4	0,70	106,3	100,1	97,5	90,8	80,0	75,1	52,1							
10SV10	2 x 4	0,70	118,0	110,8	107,9	100,3	88,2	82,8	57,2							
10SV11	2 x 4	0,70	129,6	121,3	118,1	109,6	96,3	90,3	62,1							
10SV13	2 x 5,5	0,70	156,0	146,5	142,7	132,6	116,4	109,2	74,3							

Hydraulic performances in compliance with ISO 9906:2012 - Grade 3B (ex ISO 9906:1999 - Annex A)

2p_10sv-055-2p50-en_a_th

(1) Value referred to the F, T, R, N, V, C, K versions. P version excluded.

The table refers to performance with 2 pumps running.

GS20/15SV BOOSTER SETS SERIES HYDRAULIC PERFORMANCE TABLE AT 50 HZ (SERVICE)

PUMP TYPE	RATED POWER kW	MEI ≥ (1)	Q = DELIVERY													
			l/min 0	166,7	200	266	340	366,7	466	540	660	700	800	860	920	966,7
			m ³ /h 0	10,0	12,0	16,0	20,4	22,0	28,0	32,4	39,6	42,0	48,0	51,6	55,2	58,0
H = TOTAL HEAD IN METRES OF COLUMN OF WATER																
15SV01	2 x 1,1	0,70	14,0			12,9	12,4	12,2	11,3	10,4	8,4	7,6	5,1			
15SV02	2 x 2,2	0,70	28,7			26,7	25,9	25,5	23,9	22,4	18,9	17,4	13,1			
15SV03	2 x 3	0,70	43,3			40,4	39,1	38,6	36,2	33,8	28,7	26,5	20,1			
15SV04	2 x 4	0,70	58,4			54,7	53,1	52,5	49,4	46,3	39,7	36,9	28,7			
15SV05	2 x 4	0,70	72,7			67,8	65,8	65,0	61,0	57,1	48,7	45,2	34,9			
15SV06	2 x 5,5	0,70	87,6			81,5	79,4	78,4	74,1	69,9	60,3	56,3	44,2			
15SV07	2 x 5,5	0,70	101,9			94,5	91,9	90,8	85,7	80,6	69,4	64,7	50,5			
15SV08	2 x 7,5	0,70	117,4			110,9	108,0	106,8	100,8	94,9	82,0	76,7	60,6			
15SV09	2 x 7,5	0,70	131,9			124,4	121,0	119,6	112,8	106,1	91,5	85,5	67,4			
15SV10	2 x 11	0,70	147,7			138,8	135,3	133,8	126,7	119,6	103,9	97,4	77,5			

Hydraulic performances in compliance with ISO 9906:2012 - Grade 3B (ex ISO 9906:1999 - Annex A)

2p_15sv-2p50-en_a_th

(1) Value referred to the F, T, R, N, V, C, K versions. P version excluded.

The table refers to performance with 2 pumps running.

GS20/22SV BOOSTER SETS SERIES HYDRAULIC PERFORMANCE TABLE AT 50 HZ (SERVICE)

PUMP TYPE	RATED POWER kW	MEI ≥ (1)	Q = DELIVERY														
			l/min 0	166,7	200	266	340	366,7	466	540	660	700	800	860	920	966,7	
			m ³ /h 0	10,0	12,0	16,0	20,4	22,0	28,0	32,4	39,6	42,0	48,0	51,6	55,2	58,0	
H = TOTAL HEAD IN METRES OF COLUMN OF WATER																	
22SV01	2 x 1,1	0,70	14,7						13,5	12,7	12,0	10,4	9,7	7,7	6,3	4,7	3,4
22SV02	2 x 2,2	0,70	30,4						28,4	27,2	26,0	23,3	22,2	18,9	16,6	13,8	11,5
22SV03	2 x 3	0,70	45,4						42,2	40,4	38,5	34,5	32,8	27,8	24,2	20,2	16,6
22SV04	2 x 4	0,70	60,9						56,8	54,4	51,9	46,6	44,4	37,9	33,1	27,7	23,0
22SV05	2 x 5,5	0,70	76,0						70,9	67,9	64,9	58,3	55,6	47,4	41,4	34,7	28,8
22SV06	2 x 7,5	0,70	93,2						88,8	85,7	82,5	75,4	72,4	63,3	56,7	49,1	42,6
22SV07	2 x 7,5	0,70	108,5						103,1	99,4	95,7	87,2	83,7	73,1	65,3	56,5	48,8
22SV08	2 x 11	0,70	124,6						119,2	115,2	111,0	101,6	97,7	85,7	77,0	66,9	58,2
22SV09	2 x 11	0,70	140,1						133,7	129,2	124,4	113,8	109,3	95,8	86,0	74,6	64,8
22SV10	2 x 11	0,70	155,4						148,2	143,1	137,8	125,9	120,9	105,8	94,8	82,3	71,3

Hydraulic performances in compliance with ISO 9906:2012 - Grade 3B (ex ISO 9906:1999 - Annex A)

2p_22sv-2p50-en_a_th

(1) Value referred to the F, T, R, N, V, C, K versions. P version excluded.

The table refers to performance with 2 pumps running.

GS20/33SV BOOSTER SETS SERIES HYDRAULIC PERFORMANCE TABLE AT 50 HZ (SERVICE)

PUMP TYPE	RATED POWER kW	MEI ≥ (1)	Q = DELIVERY										
			l/min 0	500	600	733	833	1000	1167	1333	1500	1800	2000
			m ³ /h 0	30	36	44	50	60	70	80	90	108	120
			H = TOTAL HEAD METRES COLUMN OF WATER										
33SV1/1A	2 x 2,2	0,70	17,4	16,2	15,7	15	14	12,2	9,8	6,7			
33SV1	2 x 3	0,70	23,8	21,7	21,2	20	20	17,8	15,5	12,7			
33SV2/2A	2 x 4	0,70	35,1	34,1	33,3	32	30	27	22,4	16,6			
33SV2/1A	2 x 4	0,70	40,8	38,8	37,9	36	35	32	27,5	22,3			
33SV2	2 x 5,5	0,70	47,8	45	44,1	43	41	39	35	29,9			
33SV3/2A	2 x 5,5	0,70	57,7	55,2	53,8	51	49	44	38	29,6			
33SV3/1A	2 x 7,5	0,70	64,5	61,3	60	58	56	51	45	37			
33SV3	2 x 7,5	0,70	71,5	67,4	66,0	64	62	58	52,0	44,6			
33SV4/2A	2 x 7,5	0,70	82	78,8	77	74	72	66	58	47,2			
33SV4/1A	2 x 11	0,70	88,9	85	83	81	78	73	65	55,1			
33SV4	2 x 11	0,70	95,9	91,1	90	87	85	80	73	63,1			
33SV5/2A	2 x 11	0,70	106	101,6	100	96	93	85	76	63			
33SV5/1A	2 x 11	0,70	112,7	107,2	105	102	99	92	82	70			
33SV5	2 x 15	0,70	120,4	114,9	113	110	107	101	92	80,5			
33SV6/2A	2 x 15	0,70	131,2	126,9	125	120	116	108	96	81,2			
33SV6/1A	2 x 15	0,70	139,1	133,5	131	128	124	116	105	90,4			
33SV6	2 x 15	0,70	145,6	139	137	133	129	121	110	96,1			
33SV7/2A	2 x 15	0,70	156	149,9	147	143	138	128	115	98,2			

Hydraulic performances in compliance with ISO 9906:2012 - Grade 3B (ex ISO 9906:1999 - Annex A)

2p_33sv-2p50-en_a_th

The table refers to performance with 2 pumps running.

(1) Value referred to the G and N versions with PN ≤ 16 bar (1600 kPa). P version is excluded.

GS20/46SV BOOSTER SETS SERIES HYDRAULIC PERFORMANCE TABLE AT 50 HZ (SERVICE)

PUMP TYPE	RATED POWER kW	MEI ≥ (1)	Q = DELIVERY										
			l/min 0	500	600	733	833	1000	1167	1333	1500	1800	2000
			m ³ /h 0	30	36	44	50	60	70	80	90	108	120
			H = TOTAL HEAD METRES COLUMN OF WATER										
46SV1/1A	2 x 3	0,70	19,5			19	18,8	17,9	16,7	15,1	13,1	8,5	4,6
46SV1	2 x 4	0,70	27,2			24,0	23,5	22,5	21,4	19,9	18,2	14,3	10,8
46SV2/2A	2 x 5,5	0,70	38,8			39,8	39,2	37,8	35,7	32,9	29,4	21,1	13,9
46SV2	2 x 7,5	0,70	52,6			48,5	48	46	44	42	39	31,4	25,1
46SV3/2A	2 x 11	0,70	64,7			65,1	64	62	60	56	52	40	30,8
46SV3	2 x 11	0,70	80,8			74,3	73	71	68	65	60	50	40,7
46SV4/2A	2 x 15	0,70	92,4			90,7	90	87	83	79	73	58	45,6
46SV4	2 x 15	0,70	107,3			99,8	98	96	92	87	82	68	55,9
46SV5/2A	2 x 18,5	0,70	117,2			114,8	113	110	106	100	93	75	60,2
46SV5	2 x 18,5	0,70	134,5			125,1	123	120	116	110	103	86	71,5
46SV6/2A	2 x 22	0,70	144			139,3	138	134	129	122	113	92	73

Hydraulic performances in compliance with ISO 9906:2012 - Grade 3B (ex ISO 9906:1999 - Annex A)

2p_46sv-2p50-en_b_th

The table refers to performance with 2 pumps running.

(1) Value referred to the G and N versions with PN ≤ 16 bar (1600 kPa). P version is excluded.

GS20/66SV BOOSTER SETS SERIES HYDRAULIC PERFORMANCE TABLE AT 50 HZ (SERVICE)

PUMP TYPE	RATED POWER kW	MEI ≥ (1)	Q = DELIVERY												
			l/min 0	1000	1200	1400	1500	1800	2000	2400	2600	2833	3200	3600	4000
			m ³ /h 0	60	72	84	90	108	120	144	156	170	192	216	240
			H = TOTAL HEAD METRES COLUMN OF WATER												
66SV1/1A	2 x 4	0,70	23,8	21,4	20,7	19,9	19,4	17,8	16,6	13,3	11,2	8,3			
66SV1	2 x 5,5	0,70	29,2	25,8	24,8	23,8	23,3	21,8	20,7	17,9	16,1	13,5			
66SV2/2A	2 x 7,5	0,70	47,5	42,6	41,2	39,5	38,6	36	32,9	26,4	22,2	16,4			
66SV2/1A	2 x 11	0,70	54,2	49,6	48,2	46,7	45,8	42,9	40,6	34,8	31,2	26,2			
66SV2	2 x 11	0,70	60,4	55,7	54,4	52,8	52	49,3	47,1	42	38,9	34,7			
66SV3/2A	2 x 15	0,70	78,4	71,6	70	67	66	62	58	49	43,3	35,3			
66SV3/1A	2 x 15	0,70	84,7	77,8	76	74	72	68	65	56	51	44,0			
66SV3	2 x 18,5	0,70	91,4	84,7	83	81	79	75	72	64	60	53,5			
66SV4/2A	2 x 18,5	0,70	108,9	99,6	97	94	92	86	82	70	63	52,8			
66SV4/1A	2 x 22	0,70	115,2	105,9	103	100	99	93	89	78	71	61,8			
66SV4	2 x 22	0,70	121,6	112,5	110	107	105	100	96	86	79	70,8			
66SV5/2A	2 x 30	0,70	139,1	127,5	124	120	118	111	106	92	83	70,4			
66SV5/1A	2 x 30	0,70	145,6	134	131	127	125	118	112	99	91	79,5			
66SV5	2 x 30	0,70	152	140,4	137	133	131	125	119	107	99	88,5			

Hydraulic performances in compliance with ISO 9906:2012 - Grade 3B (ex ISO 9906:1999 - Annex A)

2p_66sv-2p50-en_a_th

The table refers to performance with 2 pumps running.

(1) Value referred to the G and N versions with PN ≤ 16 bar (1600 kPa). P version is excluded.

GS20/92SV BOOSTER SETS SERIES HYDRAULIC PERFORMANCE TABLE AT 50 HZ (SERVICE)

PUMP TYPE	RATED POWER kW	MEI ≥ (1)	Q = DELIVERY												
			l/min 0	1000	1200	1400	1500	1800	2000	2400	2600	2833	3200	3600	4000
			m ³ /h 0	60	72	84	90	108	120	144	156	170	192	216	240
			H = TOTAL HEAD METRES COLUMN OF WATER												
92SV1/1A	2 x 5,5	0,60	24,5				22,2	21,5	20,9	19,4	18,5	17,3	15,0	11,8	7,9
92SV1	2 x 7,5	0,60	33,5				28,7	27,2	26,2	24,3	23,3	22,2	20,2	17,6	14,3
92SV2/2A	2 x 11	0,60	49,4				45,1	44	42,5	39,6	37,9	35,5	30,9	24,6	16,8
92SV2	2 x 15	0,60	67,8				58,2	55,3	53,4	49,5	47,6	45,2	41,4	36,3	29,6
92SV3/2A	2 x 18,5	0,60	82,4				74	71,6	69,6	65	62,1	58,6	52,2	43,6	32,9
92SV3	2 x 22	0,60	102,2				88	84	81	76	72,6	69,2	63,4	55,9	46,3
92SV4/2A	2 x 30	0,60	115,7				104	100	97	90	87	82,1	73,8	62,8	49,0
92SV4	2 x 30	0,60	133,1				117	112	108	101	97	92,3	84,6	74,8	62,5
92SV5/2A	2 x 37	0,60	149,0				133	128	124	116	111	105,2	94,9	81,4	64,6

Hydraulic performances in compliance with ISO 9906:2012 - Grade 3B (ex ISO 9906:1999 - Annex A)

2p_92sv-2p50-en_a_th

(1) Value referred to the G, N versions. P version excluded.

The table refers to performance with 2 pumps running.

GS20/125SV BOOSTER SETS SERIES HYDRAULIC PERFORMANCE TABLE AT 50 HZ (SERVICE)

PUMP TYPE	RATED POWER kW	MEI ≥	Q = DELIVERY											
			l/min 0	1500	1800	2000	2400	2832	3400	3800	4000	4300	4600	2666
			m ³ /h 0	90	108	120	144	170	204	228	240	258	276	320
			H = TOTAL HEAD IN METRES OF COLUMN OF WATER											
125SV1	2 x 7,5	-	27,6			20,8	19,8	18,6	16,8	15,3	14,4	12,9	11,3	6,2
125SV2	2 x 15	-	53,8			44,4	42,5	40,4	37,1	34,4	32,9	30,4	27,7	19,6
125SV3	2 x 22	-	80,7			66,5	63,8	60,6	55,7	51,6	49,4	45,7	41,5	29,4
125SV4	2 x 30	-	107,6			88,7	85,0	80,7	74,2	68,8	65,8	60,9	55,4	39,2
125SV5	2 x 37	-	134,5			110,9	106,3	100,9	92,8	86,0	82,3	76,1	69,2	49,0

Hydraulic performances in compliance with ISO 9906:2012 - Grade 3B (ex ISO 9906:1999 - Annex A)

2p_125sv-2p50-en_a_th

(1) Value referred to the G, N versions. P version excluded.

The table refers to performance with 2 pumps running.

GS30/10SV BOOSTER SETS SERIES HYDRAULIC PERFORMANCE TABLE AT 50 HZ (SERVICE)

PUMP TYPE	RATED POWER kW	MEI ≥ (1)	Q = DELIVERY													
			l/min 0	250	300	399	510	550	699	810	990	1050	1200	1290	1380	1450
			m ³ /h 0	15	18	23,9	30,6	33	41,9	48,6	59,4	63	72	77,4	82,8	87
H = TOTAL HEAD IN METRES OF COLUMN OF WATER																
10SV01	3 x 0,75	0,70	11,8	11,2	10,9	9,9	8,3	7,6	4,3							
10SV02	3 x 0,75	0,70	23,6	21,9	21,3	19,6	17,0	15,8	10,0							
10SV03	3 x 1,1	0,70	35,7	33,0	32,1	29,6	25,8	24,1	16,0							
10SV04	3 x 1,5	0,70	47,7	44,2	43,0	39,9	34,8	32,6	21,7							
10SV05	3 x 2,2	0,70	60,0	56,1	54,7	50,9	44,9	42,2	29,0							
10SV06	3 x 2,2	0,70	71,8	66,8	65,0	60,4	53,1	49,8	33,9							
10SV07	3 x 3	0,70	83,6	78,3	76,2	70,8	62,1	58,3	39,8							
10SV08	3 x 3	0,70	95,3	88,9	86,5	80,1	70,2	65,7	44,5							
10SV09	3 x 4	0,70	106,3	100,1	97,5	90,8	80,0	75,1	52,1							
10SV10	3 x 4	0,70	118,0	110,8	107,9	100,3	88,2	82,8	57,2							
10SV11	3 x 4	0,70	129,6	121,3	118,1	109,6	96,3	90,3	62,1							
10SV13	3 x 5,5	0,70	156,0	146,5	142,7	132,6	116,4	109,2	74,3							

Hydraulic performances in compliance with ISO 9906:2012 - Grade 3B (ex ISO 9906:1999 - Annex A)

3p_10sv-2p50-en_a_th

(1) Value referred to the F, T, R, N, V, C, K versions. P version excluded.

The table refers to performance with 3 pumps running.

GS30/15SV BOOSTER SETS SERIES HYDRAULIC PERFORMANCE TABLE AT 50 HZ (SERVICE)

PUMP TYPE	RATED POWER kW	MEI ≥ (1)	Q = DELIVERY													
			l/min 0	250	300	399	510	550	699	810	990	1050	1200	1290	1380	1450
			m ³ /h 0	15,0	18,0	23,9	30,6	33,0	41,9	48,6	59,4	63,0	72,0	77,4	82,8	87,0
H = TOTAL HEAD IN METRES OF COLUMN OF WATER																
15SV01	3 x 1,1	0,70	14,0			12,9	12,4	12,2	11,3	10,4	8,4	7,6	5,1			
15SV02	3 x 2,2	0,70	28,7			26,7	25,9	25,5	23,9	22,4	18,9	17,4	13,1			
15SV03	3 x 3	0,70	43,3			40,4	39,1	38,6	36,2	33,8	28,7	26,5	20,1			
15SV04	3 x 4	0,70	58,4			54,7	53,1	52,5	49,4	46,3	39,7	36,9	28,7			
15SV05	3 x 4	0,70	72,7			67,8	65,8	65,0	61,0	57,1	48,7	45,2	34,9			
15SV06	3 x 5,5	0,70	87,6			81,5	79,4	78,4	74,1	69,9	60,3	56,3	44,2			
15SV07	3 x 5,5	0,70	101,9			94,5	91,9	90,8	85,7	80,6	69,4	64,7	50,5			
15SV08	3 x 7,5	0,70	117,4			110,9	108,0	106,8	100,8	94,9	82,0	76,7	60,6			
15SV09	3 x 7,5	0,70	131,9			124,4	121,0	119,6	112,8	106,1	91,5	85,5	67,4			
15SV10	3 x 11	0,70	147,7			138,8	135,3	133,8	126,7	119,6	103,9	97,4	77,5			

Hydraulic performances in compliance with ISO 9906:2012 - Grade 3B (ex ISO 9906:1999 - Annex A)

3p_15sv-2p50-en_a_th

(1) Value referred to the F, T, R, N, V, C, K versions. P version excluded.

The table refers to performance with 3 pumps running.

GS30/22SV BOOSTER SETS SERIES HYDRAULIC PERFORMANCE TABLE AT 50 HZ (SERVICE)

PUMP TYPE	RATED POWER kW	MEI ≥ (1)	Q = DELIVERY														
			l/min 0	83,34	100	133	170	183,3	233	270	330	350	400	430	460	483,3	
			m ³ /h 0	5,0	6,0	8,0	10,2	11,0	14,0	16,2	19,8	21,0	24,0	25,8	27,6	29,0	
H = TOTAL HEAD IN METRES OF COLUMN OF WATER																	
22SV01	3 x 1,1	0,70	14,7						13,5	12,7	12,0	10,4	9,7	7,7	6,3	4,7	3,4
22SV02	3 x 2,2	0,70	30,4						28,4	27,2	26,0	23,3	22,2	18,9	16,6	13,8	11,5
22SV03	3 x 3	0,70	45,4						42,2	40,4	38,5	34,5	32,8	27,8	24,2	20,2	16,6
22SV04	3 x 4	0,70	60,9						56,8	54,4	51,9	46,6	44,4	37,9	33,1	27,7	23,0
22SV05	3 x 5,5	0,70	76,0						70,9	67,9	64,9	58,3	55,6	47,4	41,4	34,7	28,8
22SV06	3 x 7,5	0,70	93,2						88,8	85,7	82,5	75,4	72,4	63,3	56,7	49,1	42,6
22SV07	3 x 7,5	0,70	108,5						103,1	99,4	95,7	87,2	83,7	73,1	65,3	56,5	48,8
22SV08	3 x 11	0,70	124,6						119,2	115,2	111,0	101,6	97,7	85,7	77,0	66,9	58,2
22SV09	3 x 11	0,70	140,1						133,7	129,2	124,4	113,8	109,3	95,8	86,0	74,6	64,8
22SV10	3 x 11	0,70	155,4						148,2	143,1	137,8	125,9	120,9	105,8	94,8	82,3	71,3

Hydraulic performances in compliance with ISO 9906:2012 - Grade 3B (ex ISO 9906:1999 - Annex A)

3p_22sv-2p50-en_a_th

(1) Value referred to the F, T, R, N, V, C, K versions. P version excluded.

The table refers to performance with 3 pumps running.

GS30/33SV BOOSTER SETS SERIES HYDRAULIC PERFORMANCE TABLE AT 50 HZ (SERVICE)

PUMP TYPE	RATED POWER kW	MEI ≥ (1)	Q = DELIVERY										
			l/min 0 m ³ /h 0	750 45	900 54	1100 66	1250 75	1500 90	1750 105	2000 120	2250 135	2700 162	3000 180
H = TOTAL HEAD METRES COLUMN OF WATER													
33SV1/1A	3 x 2,2	0,70	17,4	16,2	15,7	15	14	12,2	9,8	6,7			
33SV1	3 x 3	0,70	23,8	21,7	21,2	20	20	17,8	15,5	12,7			
33SV2/2A	3 x 4	0,70	35,1	34,1	33,3	32	30	27	22,4	16,6			
33SV2/1A	3 x 4	0,70	40,8	38,8	37,9	36	35	32	27,5	22,3			
33SV2	3 x 5,5	0,70	47,8	45	44,1	43	41	39	35	29,9			
33SV3/2A	3 x 5,5	0,70	57,7	55,2	53,8	51	49	44	38	29,6			
33SV3/1A	3 x 7,5	0,70	64,5	61,3	60	58	56	51	45	37			
33SV3	3 x 7,5	0,70	71,5	67,4	66,0	64	62	58	52,0	44,6			
33SV4/2A	3 x 7,5	0,70	82	78,8	77	74	72	66	58	47,2			
33SV4/1A	3 x 11	0,70	88,9	85	83	81	78	73	65	55,1			
33SV4	3 x 11	0,70	95,9	91,1	90	87	85	80	73	63,1			
33SV5/2A	3 x 11	0,70	106	101,6	100	96	93	85	76	63			
33SV5/1A	3 x 11	0,70	112,7	107,2	105	102	99	92	82	70			
33SV5	3 x 15	0,70	120,4	114,9	113	110	107	101	92	80,5			
33SV6/2A	3 x 15	0,70	131,2	126,9	125	120	116	108	96	81,2			
33SV6/1A	3 x 15	0,70	139,1	133,5	131	128	124	116	105	90,4			
33SV6	3 x 15	0,70	145,6	139	137	133	129	121	110	96,1			
33SV7/2A	3 x 15	0,70	156	149,9	147	143	138	128	115	98,2			

Hydraulic performances in compliance with ISO 9906:2012 - Grade 3B (ex ISO 9906:1999 - Annex A)

3p_33sv-2p50-en_a_th

(1) Value referred to the G and N versions with PN ≤ 16 bar (1600 kPa). P version is excluded.

The table refers to performance with 3 pumps running.

GS30/46SV BOOSTER SETS SERIES HYDRAULIC PERFORMANCE TABLE AT 50 HZ (SERVICE)

PUMP TYPE	RATED POWER kW	MEI ≥ (1)	Q = DELIVERY										
			l/min 0 m ³ /h 0	750 45	900 54	1100 66	1250 75	1500 90	1750 105	2000 120	2250 135	2700 162	3000 180
H = TOTAL HEAD METRES COLUMN OF WATER													
46SV1/1A	3 x 3	0,70	19,5			19	18,8	17,9	16,7	15,1	13,1	8,5	4,6
46SV1	3 x 4	0,70	27,2			24,0	23,5	22,5	21,4	19,9	18,2	14,3	10,8
46SV2/2A	3 x 5,5	0,70	38,8			39,8	39,2	37,8	35,7	32,9	29,4	21,1	13,9
46SV2	3 x 7,5	0,70	52,6			48,5	48	46	44	42	39	31,4	25,1
46SV3/2A	3 x 11	0,70	64,7			65,1	64	62	60	56	52	40	30,8
46SV3	3 x 11	0,70	80,8			74,3	73	71	68	65	60	50	40,7
46SV4/2A	3 x 15	0,70	92,4			90,7	90	87	83	79	73	58	45,6
46SV4	3 x 15	0,70	107,3			99,8	98	96	92	87	82	68	55,9
46SV5/2A	3 x 18,5	0,70	117,2			114,8	113	110	106	100	93	75	60,2
46SV5	3 x 18,5	0,70	134,5			125,1	123	120	116	110	103	86	71,5
46SV6/2A	3 x 22	0,70	144			139,3	138	134	129	122	113	92	73

Hydraulic performances in compliance with ISO 9906:2012 - Grade 3B (ex ISO 9906:1999 - Annex A)

3p_46sv-2p50-en_b_th

The table refers to performance with 3 pumps running.

(1) Value referred to the G and N versions with PN ≤ 16 bar (1600 kPa). P version is excluded.

GS30/66SV BOOSTER SETS SERIES HYDRAULIC PERFORMANCE TABLE AT 50 HZ (SERVICE)

PUMP TYPE	RATED POWER kW	MEI ≥ (1)	Q = DELIVERY												
			l/min 0	1500	1800	2100	2250	2700	3000	3600	3900	4250	4800	5400	6000
			m ³ /h 0	90	108	126	135	162	180	216	234	255	288	324	360
H = TOTAL HEAD METRES COLUMN OF WATER															
66SV1/1A	3 x 4	0,70	23,8	21,4	20,7	19,9	19,4	17,8	16,6	13,3	11,2	8,3			
66SV1	3 x 5,5	0,70	29,2	25,8	24,8	23,8	23,3	21,8	20,7	17,9	16,1	13,5			
66SV2/2A	3 x 7,5	0,70	47,5	42,6	41,2	39,5	38,6	36	32,9	26,4	22,2	16,4			
66SV2/1A	3 x 11	0,70	54,2	49,6	48,2	46,7	45,8	42,9	40,6	34,8	31,2	26,2			
66SV2	3 x 11	0,70	60,4	55,7	54,4	52,8	52	49,3	47,1	42	38,9	34,7			
66SV3/2A	3 x 15	0,70	78,4	71,6	70	67	66	62	58	49	43,3	35,3			
66SV3/1A	3 x 15	0,70	84,7	77,8	76	74	72	68	65	56	51	44,0			
66SV3	3 x 18,5	0,70	91,4	84,7	83	81	79	75	72	64	60	53,5			
66SV4/2A	3 x 18,5	0,70	108,9	99,6	97	94	92	86	82	70	63	52,8			
66SV4/1A	3 x 22	0,70	115,2	105,9	103	100	99	93	89	78	71	61,8			
66SV4	3 x 22	0,70	121,6	112,5	110	107	105	100	96	86	79	70,8			
66SV5/2A	3 x 30	0,70	139,1	127,5	124	120	118	111	106	92	83	70,4			
66SV5/1A	3 x 30	0,70	145,6	134	131	127	125	118	112	99	91	79,5			
66SV5	3 x 30	0,70	152	140,4	137	133	131	125	119	107	99	88,5			

Hydraulic performances in compliance with ISO 9906:2012 - Grade 3B (ex ISO 9906:1999 - Annex A)

3p_66sv-2p50-en_a_th

(1) Value referred to the G, N versions. P version excluded.

The table refers to performance with 3 pumps running.

GS30/92SV BOOSTER SETS SERIES HYDRAULIC PERFORMANCE TABLE AT 50 HZ (SERVICE)

PUMP TYPE	RATED POWER kW	MEI ≥ (1)	Q = DELIVERY												
			l/min 0	1500	1800	2100	2250	2700	3000	3600	3900	4250	4800	5400	6000
			m ³ /h 0	90	108	126	135	162	180	216	234	255	288	324	360
H = TOTAL HEAD METRES COLUMN OF WATER															
92SV1/1A	3 x 5,5	0,60	24,5				22,2	21,5	20,9	19,4	18,5	17,3	15,0	11,8	7,9
92SV1	3 x 7,5	0,60	33,5				28,7	27,2	26,2	24,3	23,3	22,2	20,2	17,6	14,3
92SV2/2A	3 x 11	0,60	49,4				45,1	44	42,5	39,6	37,9	35,5	30,9	24,6	16,8
92SV2	3 x 15	0,60	67,8				58,2	55,3	53,4	49,5	47,6	45,2	41,4	36,3	29,6
92SV3/2A	3 x 18,5	0,60	82,4				74	71,6	69,6	65	62,1	58,6	52,2	43,6	32,9
92SV3	3 x 22	0,60	102,2				88	84	81	76	72,6	69,2	63,4	55,9	46,3
92SV4/2A	3 x 30	0,60	115,7				104	100	97	90	87	82,1	73,8	62,8	49,0
92SV4	3 x 30	0,60	133,1				117	112	108	101	97	92,3	84,6	74,8	62,5
92SV5/2A	3 x 37	0,60	149,0				133	128	124	116	111	105,2	94,9	81,4	64,6

Hydraulic performances in compliance with ISO 9906:2012 - Grade 3B (ex ISO 9906:1999 - Annex A)

3p_92sv-2p50-en_a_th

(1) Value referred to the G, N versions. P version excluded.

The table refers to performance with 3 pumps running.

GS30/125SV BOOSTER SETS SERIES HYDRAULIC PERFORMANCE TABLE AT 50 HZ (SERVICE)

PUMP TYPE	RATED POWER kW	MEI ≥	Q = DELIVERY												
			l/min 0	2250	2700	3000	3600	4248	5100	5700	6000	6450	6900	2666	
			m ³ /h 0	135	162	180	216	255	306	342	360	387	414	480	
H = TOTAL HEAD IN METRES OF COLUMN OF WATER															
125SV1	3 x 7,5	-	27,6				20,8	19,8	18,6	16,8	15,3	14,4	12,9	11,3	6,2
125SV2	3 x 15	-	53,8				44,4	42,5	40,4	37,1	34,4	32,9	30,4	27,7	19,6
125SV3	3 x 22	-	80,7				66,5	63,8	60,6	55,7	51,6	49,4	45,7	41,5	29,4
125SV4	3 x 30	-	107,6				88,7	85,0	80,7	74,2	68,8	65,8	60,9	55,4	39,2
125SV5	3 x 37	-	134,5				110,9	106,3	100,9	92,8	86,0	82,3	76,1	69,2	49,0

Hydraulic performances in compliance with ISO 9906:2012 - Grade 3B (ex ISO 9906:1999 - Annex A)

3p_125sv-2p50-en_a_th

(1) Value referred to the G, N versions. P version excluded.

The table refers to performance with 3 pumps running.

GS20, GS30/10SV-33SV BOOSTER SETS SERIES ELECTRIC DATA TABLES AT 50 Hz

SERVICE PUMP 3 X 400 V			CURRENT ABSORBED BY SET 3 X 400V	
TYPE	P _n kW	I _n A	GS20 A	GS30 A
10SV01	0,75	1,70	-	5,1
10SV02	0,75	1,70	-	5,1
10SV03	1,1	2,39	-	7,2
10SV04	1,5	3,17	-	9,5
10SV05	2,2	4,64	-	13,9
10SV06	2,2	4,64	-	13,9
10SV07	3	6,14	-	18,4
10SV08	3	6,14	-	18,4
10SV09	4	7,63	15,3	22,9
10SV10	4	7,63	15,3	22,9
10SV11	4	7,63	15,3	22,9
10SV13	5,5	10,40	20,8	31,2
15SV01	1,1	2,39	4,8	7,2
15SV02	2,2	4,64	9,3	13,9
15SV03	3	6,14	12,3	18,4
15SV04	4	7,63	15,3	22,9
15SV05	4	7,63	15,3	22,9
15SV06	5,5	10,40	20,8	31,2
15SV07	5,5	10,40	20,8	31,2
15SV08	7,5	14,00	28,0	42,0
15SV09	7,5	14,00	28,0	42,0
15SV10	11	20,30	40,6	60,9
22SV01	1,1	2,39	4,8	7,2
22SV02	2,2	4,64	9,3	13,9
22SV03	3	6,14	12,3	18,4
22SV04	4	7,63	15,3	22,9
22SV05	5,5	10,40	20,8	31,2
22SV06	7,5	14,00	28,0	42,0
22SV07	7,5	14,00	28,0	42,0
22SV08	11	20,30	40,6	60,9
22SV09	11	20,30	40,6	60,9
22SV10	11	20,30	40,6	60,9
33SV1/1A	2,2	4,64	9,3	13,9
33SV1	3	6,14	12,3	18,4
33SV2/2A	4	7,63	15,3	22,9
33SV2/1A	4	7,63	15,3	22,9
33SV2	5,5	10,40	20,8	31,2
33SV3/2A	5,5	10,40	20,8	31,2
33SV3/1A	7,5	14,00	28,0	42,0
33SV3	7,5	14,00	28,0	42,0
33SV4/2A	7,5	14,00	28,0	42,0
33SV4/1A	11	20,30	40,6	60,9
33SV4	11	20,30	40,6	60,9
33SV5/2A	11	20,30	40,6	60,9
33SV5/1A	11	20,30	40,6	60,9
33SV5	15	26,00	52,0	78,0
33SV6/2A	15	26,00	52,0	78,0
33SV6/1A	15	26,00	52,0	78,0
33SV6	15	26,00	52,0	78,0
33SV7/2A	15	26,00	52,0	78,0

The current shown is the nominal current of the set.

gms_10-33sv_2p50-en_e_te

GS20, GS30/46SV-125SV BOOSTER SETS SERIES ELECTRIC DATA TABLES AT 50 Hz

TYPE	SERVICE PUMP 3 X 400 V		CURRENT ABSORBED BY SET 3 X 400V	
	P _n kW	I _n A	GS20 A	GS30 A
46SV1/1A	3	6,14	12,3	18,4
46SV1	4	7,63	15,3	22,9
46SV2/2A	5,5	10,40	20,8	31,2
46SV2G	7,5	14,00	28,0	42,0
46SV3/2A	11	20,30	40,6	60,9
46SV3	11	20,30	40,6	60,9
46SV4/2A	15	26,00	52,0	78,0
46SV4	15	26,00	52,0	78,0
46SV5/2A	18,5	33,20	66,4	99,6
46SV5	18,5	33,20	66,4	99,6
46SV6/2A	22	38,60	77,2	115,8
66SV1/1A	4	7,63	15,3	22,9
66SV1	5,5	10,40	20,8	31,2
66SV2/2A	7,5	14,00	28,0	42,0
66SV2/1A	11	20,30	40,6	60,9
66SV2	11	20,30	40,6	60,9
66SV3/2A	15	26,00	52,0	78,0
66SV3/1A	15	26,00	52,0	78,0
66SV3	18,5	33,20	66,4	99,6
66SV4/2A	18,5	33,20	66,4	99,6
66SV4/1A	22	38,60	77,2	115,8
66SV4	22	38,60	77,2	115,8
66SV5/2A	30	53,60	107,2	160,8
66SV5/1A	30	53,60	107,2	160,8
66SV5	30	53,60	107,2	160,8
92SV1/1A	5,5	10,40	20,8	31,2
92SV1	7,5	14,00	28,0	42,0
92SV2/2A	11	20,30	40,6	60,9
92SV2	15	26,00	52,0	78,0
92SV3/2A	18,5	33,20	66,4	99,6
92SV3	22	38,60	77,2	115,8
92SV4/2A	30	53,60	107,2	160,8
92SV4	30	53,60	107,2	160,8
92SV5/2A	37	65,80	131,6	197,4
125SV1	7,5	14,00	28,0	42,0
125SV2	15	26,00	52,0	78,0
125SV3	22	38,60	77,2	115,8
125SV4	30	53,60	107,2	160,8
125SV5	37	65,80	131,6	197,4

The current shown is the nominal current of the set.

gms_46-92sv_2p50-en_e_te

Booster sets

MARKET SECTORS
RESIDENTIAL-CIVIL, INDUSTRIAL

APPLICATIONS

- Water network supply in housing complexes, offices, hotels, shopping centres, industrial plants.
- Supply of water networks for agricultural applications (e.g. irrigation).

GSD20 - GSY20 Series

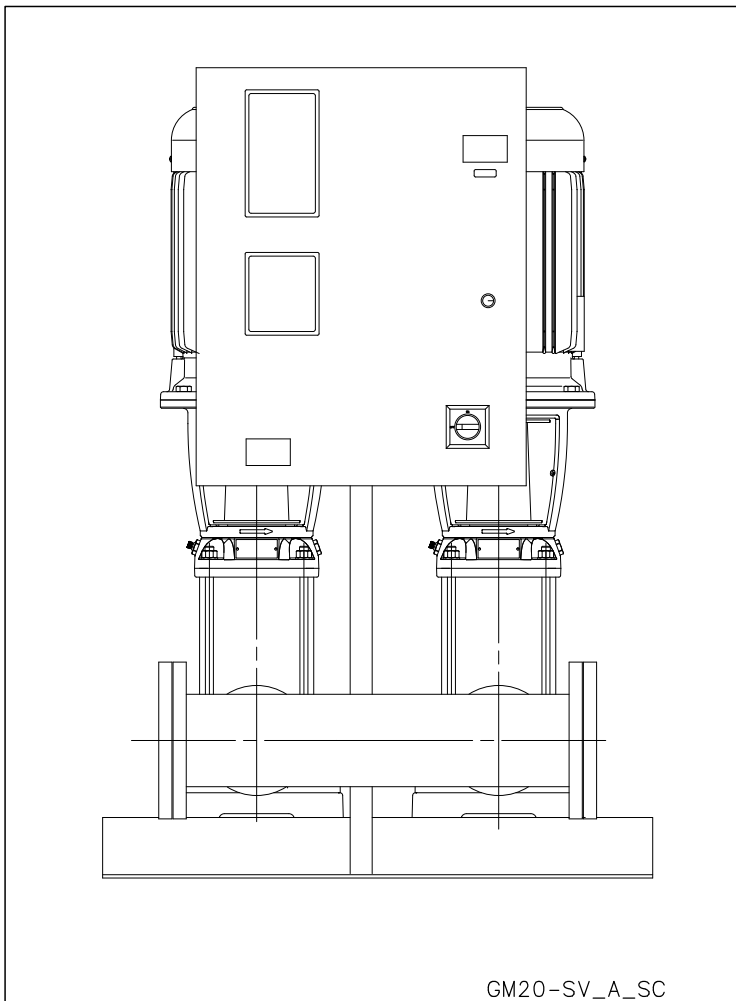

SPECIFICATIONS

- **Flow rate** up to 320 m³/h.
- **Head** up to 160 m.
- Electrical panel supply voltage: 3 x 400V ± 10%.
- Frequency 50 Hz.
- Voltage for controls outside panel: 24 Vac.
- Electrical panel protection class IP 55.
Vertical electric pumps e-SV
- Maximum service electric pump power: 2 x 37 kW.
- Motor start-up:
 - Direct for powers up to 22 kW inclusive for electric pump (GSD/).
 - Star/Delta for higher powers (GSY/ set).
 - Softstarter, available on request (GSSF/ set).
- **Electric pumps with vertical axis:**
 - SV series (motor protection class IP55).
- Maximum operating pressure: 16 bar.
- Maximum temperature of electric pumped liquid: +80°C.

GS series booster sets with e-SV series electric pumps are certified for use with drinking water.

TWO ELECTRIC PUMPS BOOSTER SETS GSD20 SERIES

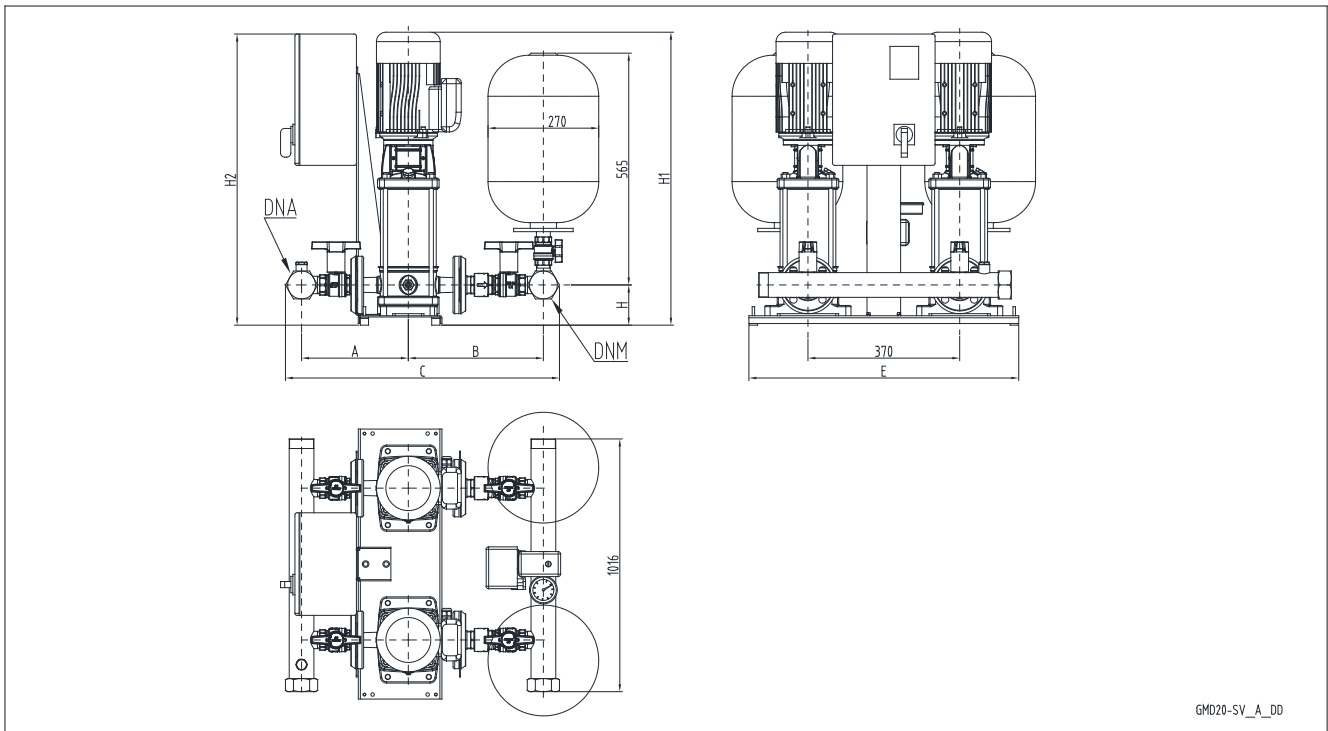

GSD 20	DNA	DNM	A		B		C		E	H	H1	H2
			STD	AISI	STD	AISI	STD	AISI				
10SV09F040T	R 2"1/2	R 2"1/2	294	301	356	453	726	830	682	114	954	640
10SV10F040T	R 2"1/2	R 2"1/2	294	301	356	453	726	830	682	114	986	640
10SV11F040T	R 2"1/2	R 2"1/2	294	301	356	453	726	830	682	114	1018	640

Dimensions in mm. ± 10 mm tolerance range.

gs20_10sv-new-small_c_td

TWO ELECTRIC PUMPS BOOSTER SETS GSD20 SERIES

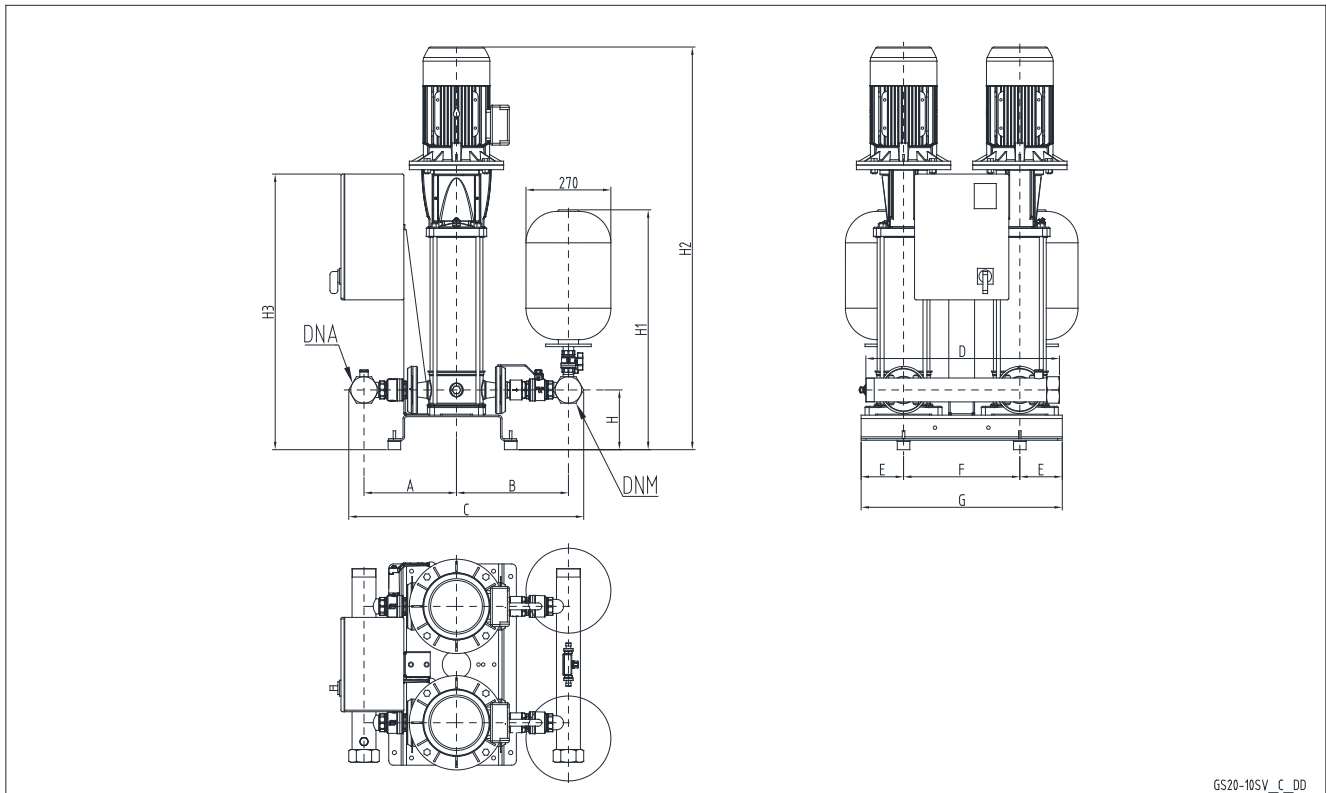

GS20-10SV_C_DD

GSD 20	DNA	DNM	A		B		C		H	H1	H2	H3
			STD	AISI	STD	AISI	STD	AISI				
10SV13F055T	R 2"1/2	R 2"1/2	294	301	356	453	726	830	190	762	1281	876
15SV01F011T	100	80	357	363	418	409	985	982	200	779	772	719
15SV02F022T	100	80	357	363	418	409	985	982	200	779	817	719
15SV03F030T	100	80	357	363	418	409	985	982	200	779	875	719
15SV04F040T	100	80	357	363	418	409	985	982	200	779	944	719
15SV05F040T	100	80	357	363	418	409	985	982	200	779	992	719
15SV06F055T	100	80	357	363	418	409	985	982	200	779	1163	876
15SV07F055T	100	80	357	363	418	409	985	982	200	779	1211	876
15SV08F075T	100	80	357	363	418	409	985	982	200	779	1251	876
15SV09F075T	100	80	357	363	418	409	985	982	200	779	1299	876
15SV10F110T	100	80	357	363	418	409	985	982	250	859	1488	926
22SV01F011T	100	100	357	363	430	421	1007	1004	200	791	772	719
22SV02F022T	100	100	357	363	430	421	1007	1004	200	791	817	719
22SV03F030T	100	100	357	363	430	421	1007	1004	200	791	875	719
22SV04F040T	100	100	357	363	430	421	1007	1004	200	791	944	719
22SV05F055T	100	100	357	363	430	421	1007	1004	200	791	1115	876
22SV06F075T	100	100	357	363	430	421	1007	1004	200	791	1155	876
22SV07F075T	100	100	357	363	430	421	1007	1004	200	791	1203	876
22SV08F110T	100	100	357	363	430	421	1007	1004	250	871	1392	926
22SV09F110T	100	100	357	363	430	421	1007	1004	250	871	1440	926
22SV10F110T	100	100	357	363	430	421	1007	1004	250	871	1488	926

Dimensions in mm. ± 10 mm tolerance range.

gs20_10sv-new_c_td

**TWO ELECTRIC PUMPS BOOSTER SETS
GSD20 SERIES**

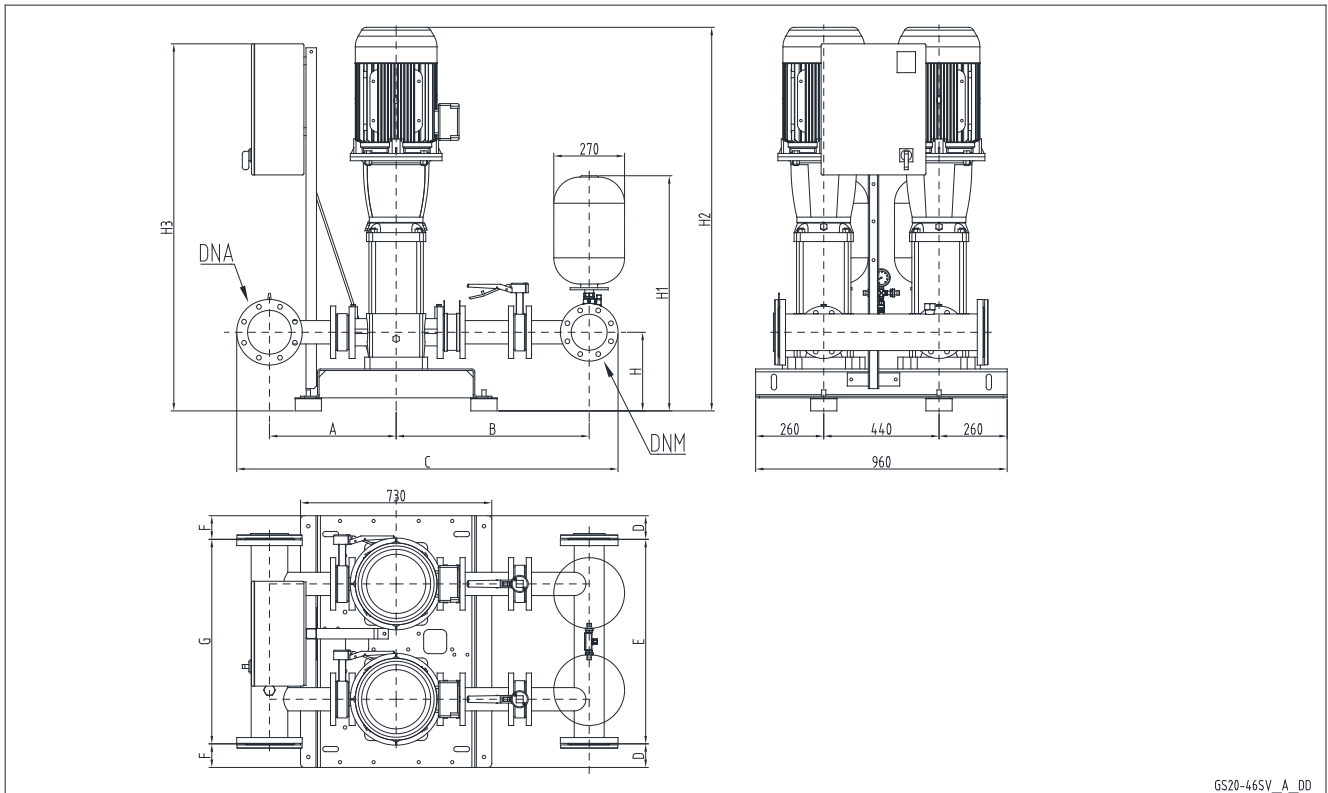

GS20-46SV_A_DD

TWO ELECTRIC PUMPS BOOSTER SETS GSD20 SERIES

GSD20	DNA	DNM	A	B	C	D	E	F	G	H	H1	H2	H3
33SV1/1AG022T	100	80	448	701	1359	90	780	90	780	265	860	947	1096
33SV1G030T	100	80	448	701	1359	90	780	90	780	265	860	947	1096
33SV2/2AG040T	100	80	448	701	1359	90	780	90	780	265	860	1043	1096
33SV2/1AG040T	100	80	448	701	1359	90	780	90	780	265	860	1043	1096
33SV2G055T	100	80	448	701	1359	90	780	90	780	265	860	1119	1176
33SV3/2AG055T	100	80	448	701	1359	90	780	90	780	265	860	1194	1176
33SV3/1AG075T	100	80	448	701	1359	90	780	90	780	265	860	1186	1176
33SV3G075T	100	80	448	701	1359	90	780	90	780	265	860	1186	1176
33SV4/2AG075T	100	80	448	701	1359	90	780	90	780	265	860	1261	1176
33SV4/1AG110T	100	80	448	701	1401	90	780	90	780	265	860	1357	1400
33SV4G110T	100	80	448	701	1401	90	780	90	780	265	860	1357	1400
33SV5/2AG110T	100	80	448	701	1401	90	780	90	780	265	860	1432	1400
33SV5/1AG110T	100	80	448	701	1401	90	780	90	780	265	860	1432	1400
33SV5G150T	100	80	448	701	1401	90	780	90	780	265	860	1498	1400
33SV6/2AG150T	100	80	448	701	1401	90	780	90	780	265	860	1573	1400
33SV6/1AG150T	100	80	448	701	1401	90	780	90	780	265	860	1573	1400
33SV6G150T	100	80	448	701	1401	90	780	90	780	265	860	1573	1400
33SV7/2AG150T	100	80	448	701	1401	90	780	90	780	265	860	1648	1400
46SV1/1AG030T	125	100	484	739	1457	90	780	90	780	300	907	987	1096
46SV1G040T	125	100	484	739	1457	90	780	90	780	300	907	1008	1096
46SV2/2AG055T	125	100	484	739	1457	90	780	90	780	300	907	1159	1176
46SV2G075T	125	100	484	739	1457	90	780	90	780	300	907	1151	1176
46SV3/2AG110T	125	100	484	739	1457	90	780	90	780	300	907	1322	1400
46SV3G110T	125	100	484	739	1457	90	780	90	780	300	907	1322	1400
46SV4/2AG150T	125	100	484	739	1457	90	780	90	780	300	907	1463	1400
46SV4G150T	125	100	484	739	1457	90	780	90	780	300	907	1463	1400
46SV5/2AG185T	125	100	484	739	1457	90	780	90	780	300	907	1538	1400
46SV5G185T	125	100	484	739	1457	90	780	90	780	300	907	1538	1400
46SV6/2AG220T	125	100	484	739	1499	90	780	90	780	300	907	1613	1400
46SV6G220T	125	100	484	739	1499	90	780	90	780	300	907	1613	1400
66SV1/1AG040T	150	125	504	780	1551	90	780	70	820	300	920	1033	1096
66SV1G055T	150	125	504	780	1551	90	780	70	820	300	920	1109	1176
66SV2/2AG075T	150	125	504	780	1551	90	780	70	820	300	920	1191	1176
66SV2/1AG110T	150	125	504	780	1551	90	780	70	820	300	920	1287	1400
66SV2G110T	150	125	504	780	1551	90	780	70	820	300	920	1287	1400
66SV3/2AG150T	150	125	504	780	1551	90	780	70	820	300	920	1443	1400
66SV3/1AG150T	150	125	504	780	1551	90	780	70	820	300	920	1443	1400
66SV3G185T	150	125	504	780	1551	90	780	70	820	300	920	1443	1400
66SV4/2AG185T	150	125	504	780	1551	90	780	70	820	300	920	1533	1400
66SV4/1AG220T	150	125	504	780	1555	90	780	70	820	300	920	1533	1400
66SV4G220T	150	125	504	780	1555	90	780	70	820	300	920	1533	1400
92SV1/1AG055T	200	150	529	794	1635	70	820	70	820	300	934	1109	1176
92SV1G075T	200	150	529	794	1635	70	820	70	820	300	934	1101	1176
92SV2/2AG110T	200	150	529	794	1635	70	820	70	820	300	934	1287	1400
92SV2G150T	200	150	529	794	1635	70	820	70	820	300	934	1353	1400
92SV3/2AG185T	200	150	529	794	1635	70	820	70	820	300	934	1443	1400
92SV3G220T	200	150	529	794	1635	70	820	70	820	300	934	1443	1400

Dimensions in mm. ± 10 mm tolerance range.

gs20_sv46_d_td16

TWO ELECTRIC PUMPS BOOSTER SETS GSY20 SERIES

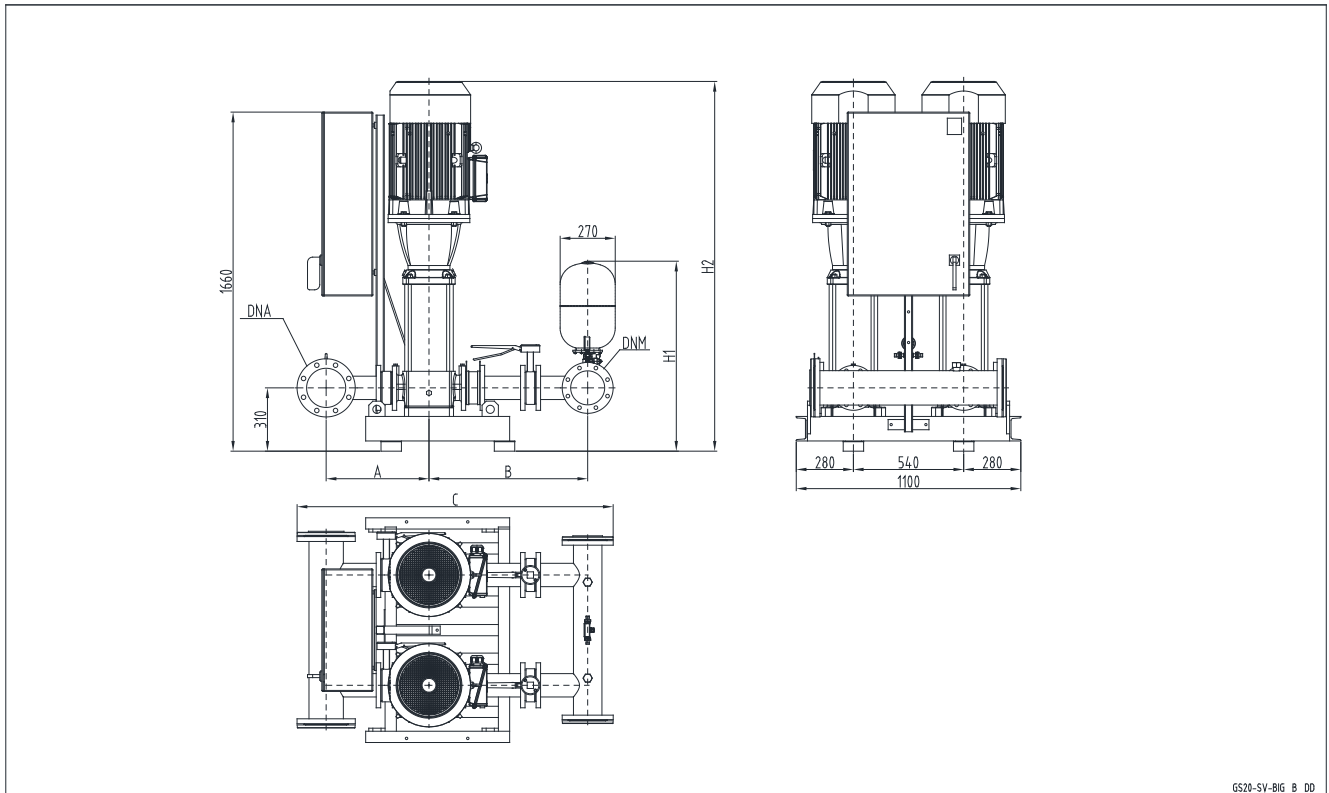

GS20-SV-BIG_B_DD

GSY20	DNA	DNM	A	B	C	H1	H2
66SV5/2AG300T	150	125	504	777	1549	930	1810
66SV5/1AG300T	150	125	504	777	1549	930	1810
66SV5G300T	150	125	504	777	1549	930	1810
92SV4/2AG300T	200	150	529	794	1635	944	1720
92SV4G300T	200	150	529	794	1635	944	1720
92SV5/2AG370T	200	150	529	794	1635	944	1810

Dimensions in mm. ± 10 mm tolerance range.

gs20_sv-big_e_td

TWO ELECTRIC PUMPS BOOSTER SETS GSD20 SERIES

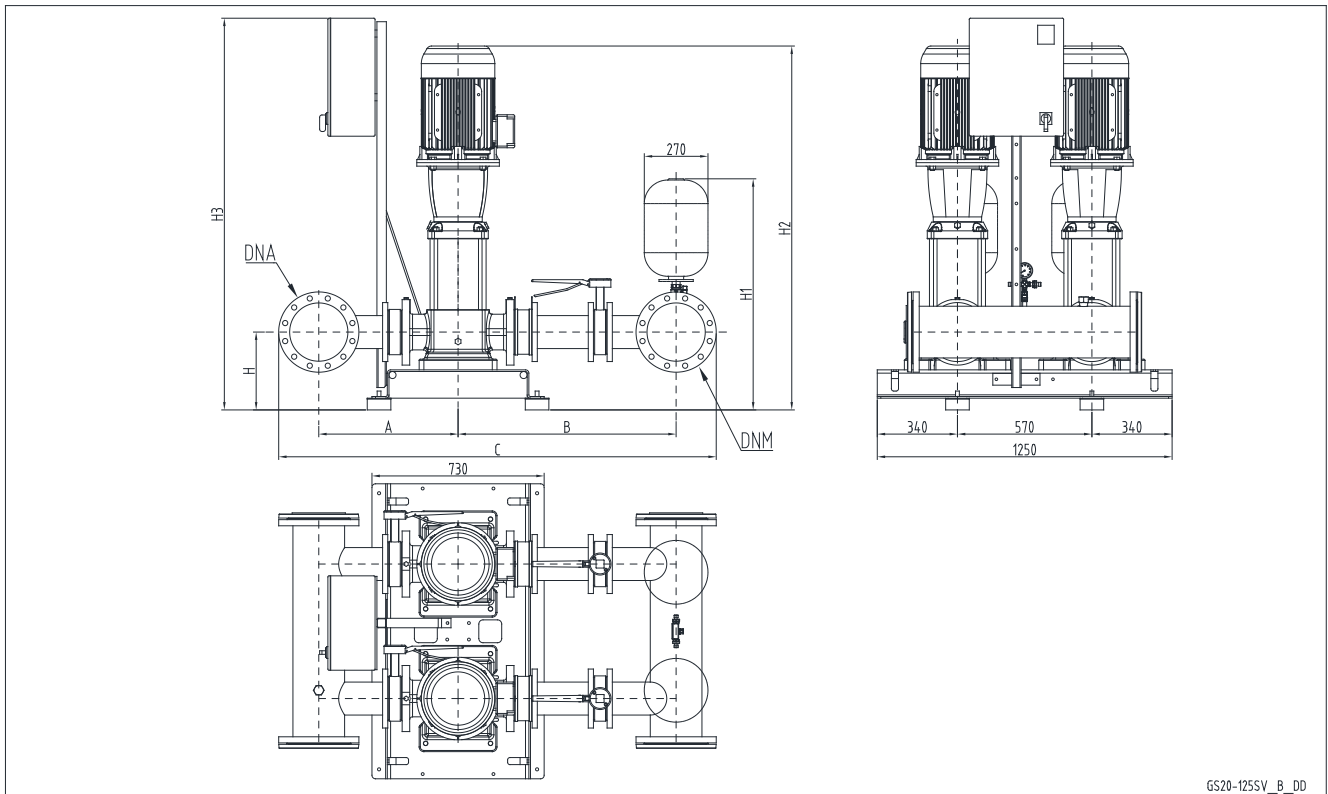

GS20-125SV_B_DD

GSD20	DNA	DNM	A	B	C	D	E	F	G	H	H1	H2	H3
125SV1G075T	200	200	591	927	1857	150	950	150	950	330	990	1230	1660
125SV2G150T	200	200	591	927	1857	150	950	150	950	330	990	1542	1660
125SV3G220T	200	200	591	927	1857	150	950	150	950	330	990	1692	1660

Dimensions in mm. ± 10 mm tolerance range.

gs20_125sv_b_td

TWO ELECTRIC PUMPS BOOSTER SETS GSY20 SERIES

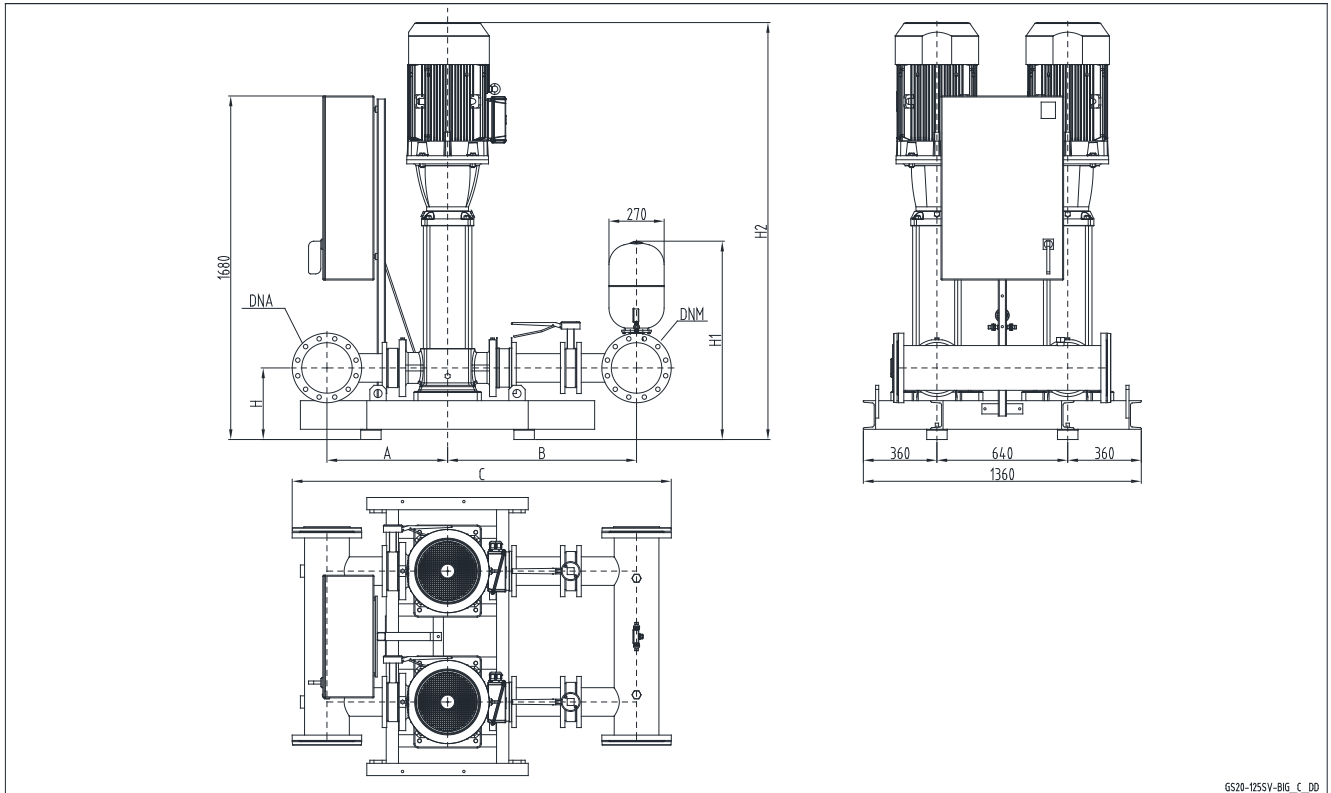

GSY20	DNA	DNM	A	B	C	H	H1	H2
125SV4G300T	200	200	591	927	1857	350	1010	2189
125SV5G370T	200	200	591	927	1857	350	1010	2369

Dimensions in mm. ± 10 mm tolerance range.

gs20_125sv-big_c_td

Booster sets

MARKET SECTORS
RESIDENTIAL-CIVIL, INDUSTRIAL

APPLICATIONS

- Water network supply in housing complexes, offices, hotels, shopping centres, industrial plants.
- Supply of water networks for agricultural applications (e.g. irrigation).

GSD30 - GSY30 Series

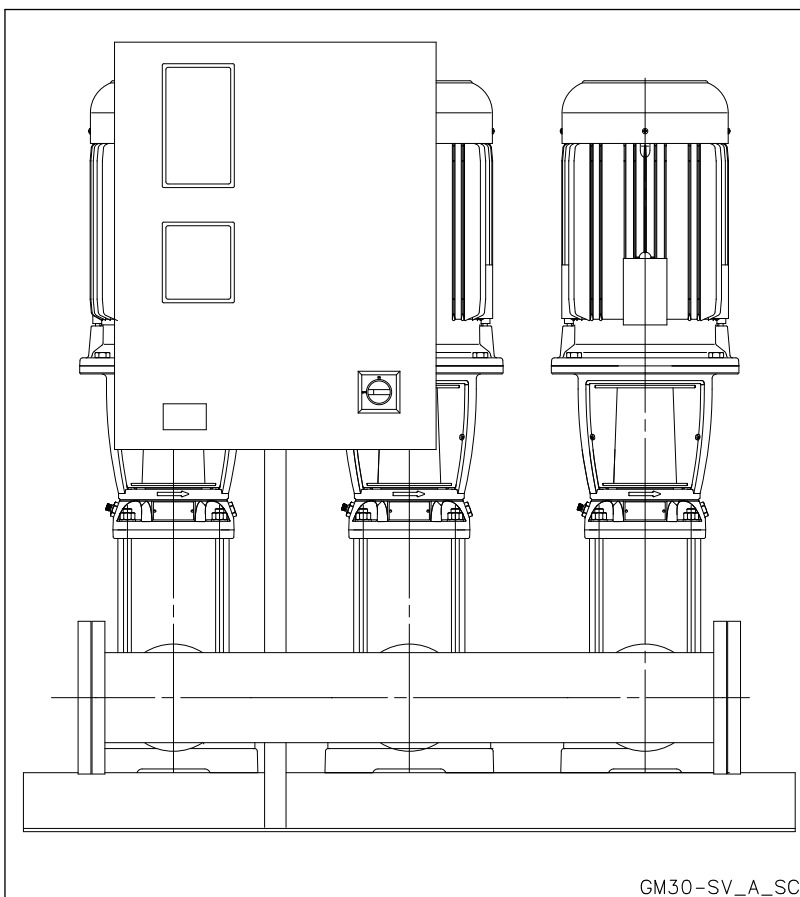

SPECIFICATIONS

- **Flow rate** up to 480 m³/h.
- **Head** up to 160 m.
- Electrical panel supply voltage: 3 x 400V ± 10%.
- Frequency 50 Hz.
- Voltage for controls outside panel: 24 Vac.
- Electrical panel protection class IP 55.
Vertical electric pumps e-SV
- Maximum service electric pump power: 3 x 37 kW.
- Motor start-up:
 - Direct for powers up to 22 kW inclusive for electric pump (GSD/).
 - Star/Delta for higher powers (GSY/ set).
 - Softstarter, available on request (GSSF/ set).
- **Electric pumps with vertical axis:**
 - SV series (motor protection class IP55).
- Maximum operating pressure: 16 bar.
- Maximum temperature of electric pumped liquid: +80°C.

GS series booster sets with e-SV series electric pumps are certified for use with drinking water.

THREE ELECTRIC PUMPS BOOSTER SETS GSD30 SERIES

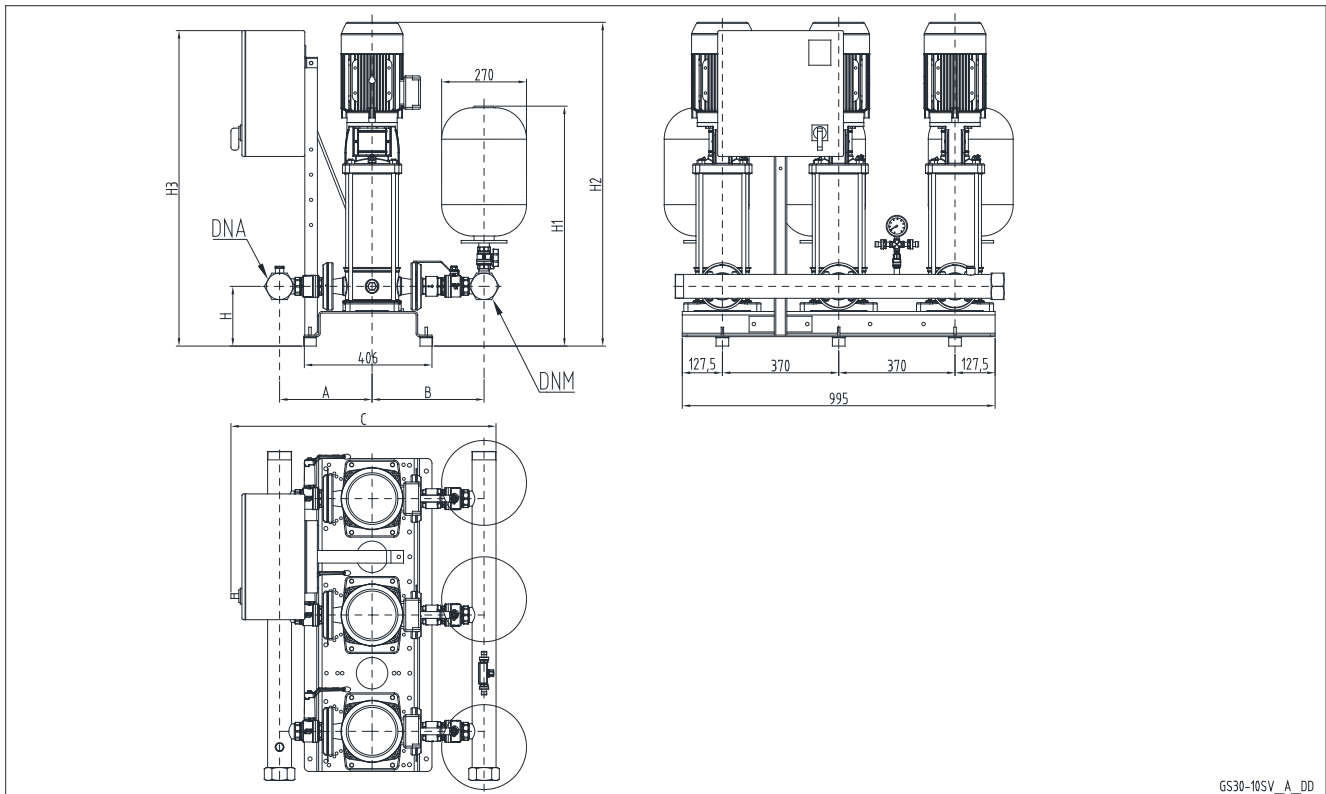

GS30-10SV_A_DD

GSD 30	DNA	DNM	A		B		C		D	H	H1	H2	H3
			STD	AISI	STD	AISI	STD	AISI					
10SV01F007T	R 2"1/2	R 2"1/2	294	301	356	453	843	940	1040	190	762	730	1003
10SV02F007T	R 2"1/2	R 2"1/2	294	301	356	453	843	940	1040	190	762	730	1003
10SV03F011T	R 2"1/2	R 2"1/2	294	301	356	453	843	940	1040	190	762	762	1003
10SV04F015T	R 2"1/2	R 2"1/2	294	301	356	453	843	940	1040	190	762	804	1003
10SV05F022T	R 2"1/2	R 2"1/2	294	301	356	453	843	940	1040	190	762	871	1003
10SV06F022T	R 2"1/2	R 2"1/2	294	301	356	453	843	940	1040	190	762	903	1003
10SV07F030T	R 2"1/2	R 2"1/2	294	301	356	453	843	940	1040	190	762	945	1003
10SV08F030T	R 2"1/2	R 2"1/2	294	301	356	453	843	940	1040	190	762	977	1003
10SV09F040T	R 2"1/2	R 2"1/2	294	301	356	453	843	940	1040	190	762	1030	1003
10SV10F040T	R 2"1/2	R 2"1/2	294	301	356	453	843	940	1040	190	762	1062	1003
10SV11F040T	R 2"1/2	R 2"1/2	294	301	356	453	843	940	1040	190	762	1094	1003
10SV13F055T	R 2"1/2	R 2"1/2	294	301	356	453	843	940	1040	190	762	1281	1003

Dimensions in mm. ± 10 mm tolerance range.

gs30_10sv-new_d_td

THREE ELECTRIC PUMPS BOOSTER SETS GSD30 SERIES

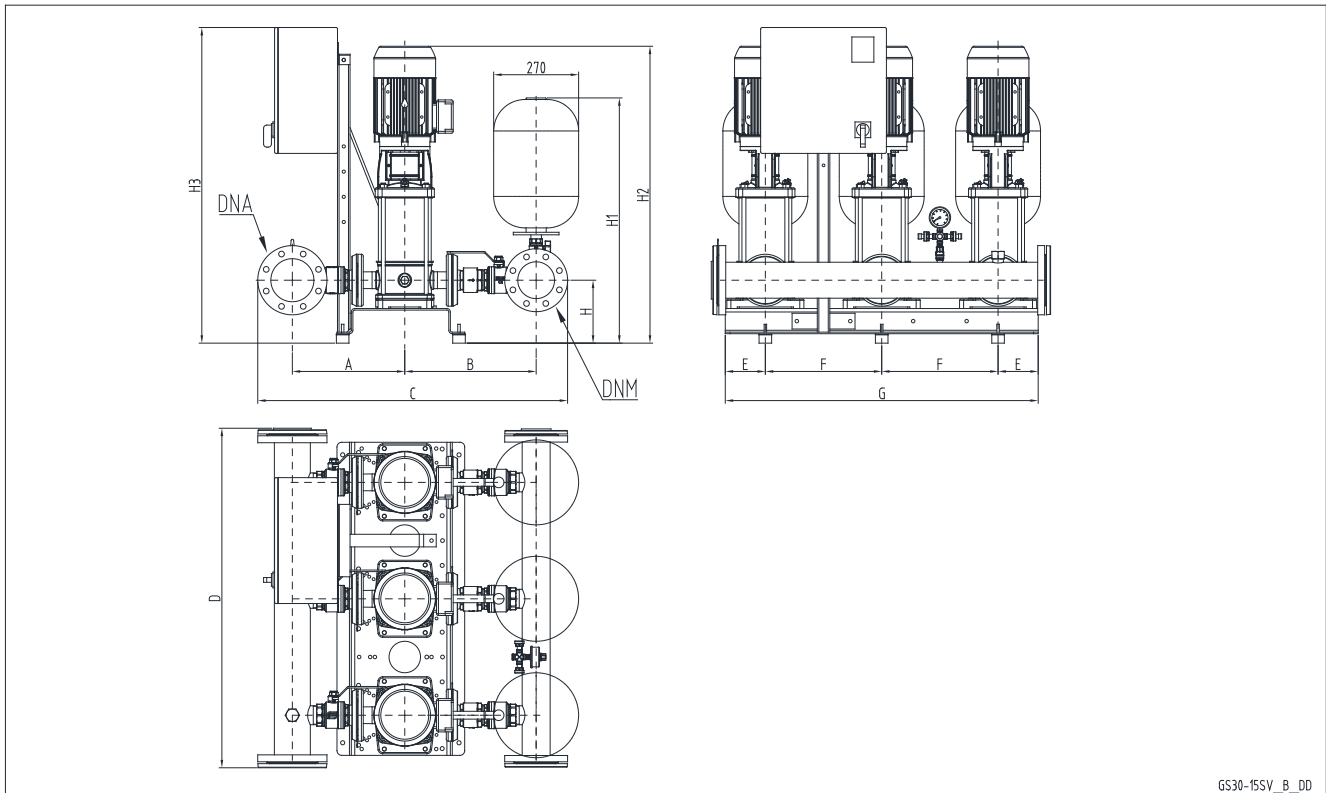

GSD30-15SV_B_00

GSD 30	DNA	DNM	A		B		C		D	E	F	G	H	H1	H2	H3
			STD	AISI	STD	AISI	STD	AISI								
15SV01F011T	100	80	357	363	418	409	985	982	1084	128	370	995	200	779	772	1003
15SV02F022T	100	80	357	363	418	409	985	982	1084	128	370	995	200	779	817	1003
15SV03F030T	100	80	357	363	418	409	985	982	1084	128	370	995	200	779	875	1003
15SV04F040T	100	80	357	363	418	409	985	982	1084	128	370	995	200	779	944	1003
15SV05F040T	100	80	357	363	418	409	985	982	1084	128	370	995	200	779	992	1003
15SV06F055T	100	80	357	363	418	409	985	982	1084	128	370	995	200	779	1163	1003
15SV07F055T	100	80	357	363	418	409	985	982	1084	128	370	995	200	779	1211	1003
15SV08F075T	100	80	357	363	418	409	985	982	1084	128	370	995	200	779	1251	1003
15SV09F075T	100	80	357	363	418	409	985	982	1084	128	370	995	200	779	1299	1003
15SV10F110T	100	80	357	363	418	409	985	982	1224	260	440	1400	280	859	1488	1620
22SV01F011T	100	100	357	363	430	421	1007	1004	1084	128	370	995	200	791	772	1003
22SV02F022T	100	100	357	363	430	421	1007	1004	1084	128	370	995	200	791	817	1003
22SV03F030T	100	100	357	363	430	421	1007	1004	1084	128	370	995	200	791	875	1003
22SV04F040T	100	100	357	363	430	421	1007	1004	1084	128	370	995	200	791	944	1003
22SV05F055T	100	100	357	363	430	421	1007	1004	1084	128	370	995	200	791	1115	1003
22SV06F075T	100	100	357	363	430	421	1007	1004	1084	128	370	995	200	791	1155	1003
22SV07F075T	100	100	357	363	430	421	1007	1004	1084	128	370	995	200	791	1203	1003
22SV08F110T	100	100	357	363	430	421	1007	1004	1224	260	440	1400	280	871	1392	1620
22SV09F110T	100	100	357	363	430	421	1007	1004	1224	260	440	1400	280	871	1440	1620
22SV10F110T	100	100	357	363	430	421	1007	1004	1224	260	440	1400	280	871	1488	1620

Dimensions in mm. ± 10 mm tolerance range.

gs30_15sv-new_f_td

**THREE ELECTRIC PUMPS BOOSTER SETS
GSD30 SERIES**

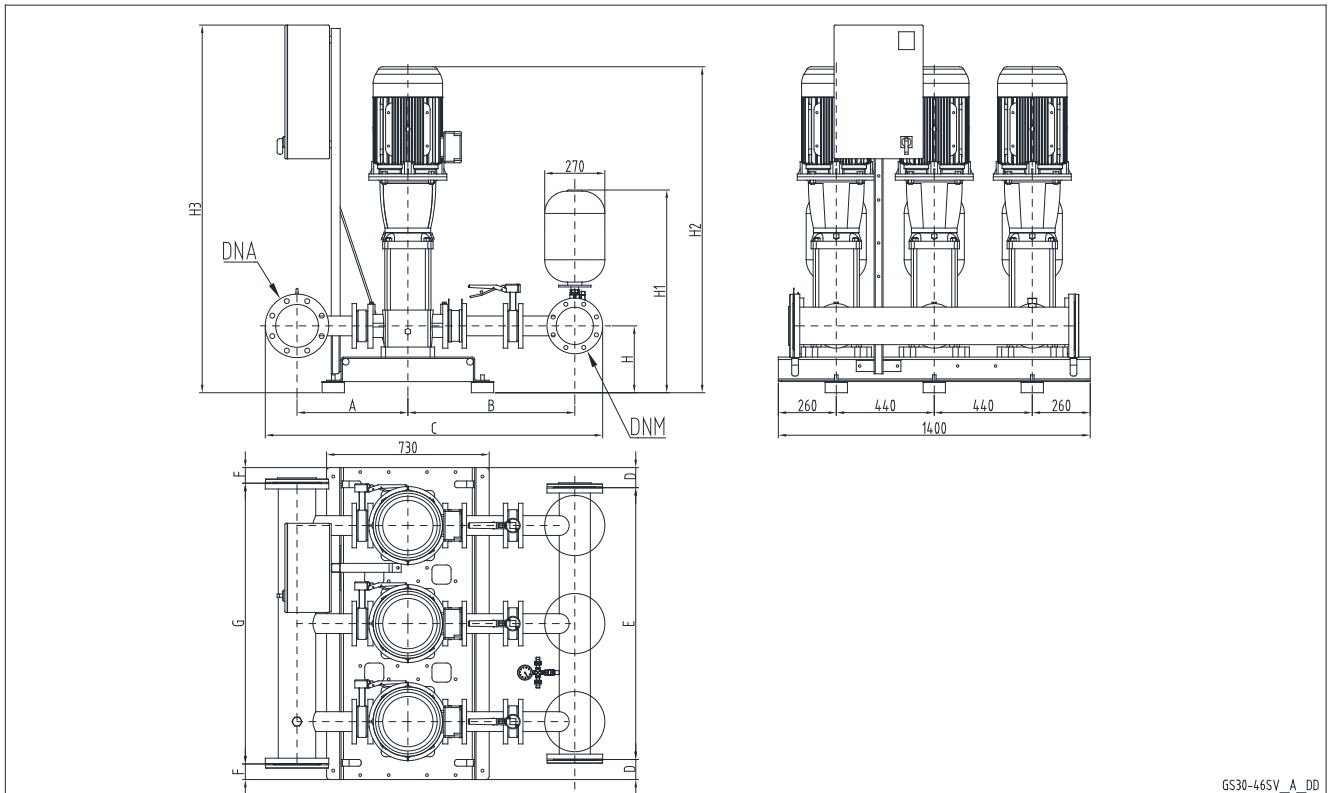

THREE ELECTRIC PUMPS BOOSTER SETS GSD30 SERIES

GSD30	DNA	DNM	A	B	C	D	E	F	G	H	H1	H2	H3
33SV1/1AG022T	125	100	461	713	1423	90	1220	90	1220	265	872	947	1053
33SV1G030T	125	100	461	713	1423	90	1220	90	1220	265	872	947	1053
33SV2/2AG040T	125	100	461	713	1423	90	1220	90	1220	265	872	1043	1053
33SV2/1AG040T	125	100	461	713	1423	90	1220	90	1220	265	872	1043	1053
33SV2G055T	125	100	461	713	1423	90	1220	90	1220	265	872	1119	1053
33SV3/2AG055T	125	100	461	713	1423	90	1220	90	1220	265	872	1194	1053
33SV3/1AG075T	125	100	461	713	1423	90	1220	90	1220	265	872	1186	1053
33SV3G075T	125	100	461	713	1423	90	1220	90	1220	265	872	1186	1053
33SV4/2AG075T	125	100	461	713	1423	90	1220	90	1220	265	872	1261	1053
33SV4/1AG110T	125	100	461	713	1423	90	1220	90	1220	265	872	1357	1650
33SV4G110T	125	100	461	713	1423	90	1220	90	1220	265	872	1357	1650
33SV5/2AG110T	125	100	461	713	1423	90	1220	90	1220	265	872	1432	1650
33SV5/1AG110T	125	100	461	713	1423	90	1220	90	1220	265	872	1432	1650
33SV5G150T	125	100	461	713	1423	90	1220	90	1220	265	872	1498	1650
33SV6/2AG150T	125	100	461	713	1423	90	1220	90	1220	265	872	1573	1650
33SV6/1AG150T	125	100	461	713	1423	90	1220	90	1220	265	872	1573	1650
33SV6G150T	125	100	461	713	1423	90	1220	90	1220	265	872	1573	1650
33SV7/2AG150T	125	100	461	713	1423	90	1220	90	1220	265	872	1648	1650
46SV1/1AG030T	150	125	498	752	1517	90	1220	70	1260	300	920	987	1053
46SV1G040T	150	125	498	752	1517	90	1220	70	1260	300	920	1008	1053
46SV2/2AG055T	150	125	498	752	1517	90	1220	70	1260	300	920	1159	1053
46SV2G075T	150	125	498	752	1517	90	1220	70	1260	300	920	1151	1053
46SV3/2AG110T	150	125	498	752	1517	90	1220	70	1260	300	920	1322	1650
46SV3G110T	150	125	498	752	1517	90	1220	70	1260	300	920	1322	1650
46SV4/2AG150T	150	125	498	752	1517	90	1220	70	1260	300	920	1463	1650
46SV4G150T	150	125	498	752	1517	90	1220	70	1260	300	920	1463	1650
46SV5/2AG185T	150	125	498	752	1517	90	1220	70	1260	300	920	1538	1900
46SV5G185T	150	125	498	752	1517	90	1220	70	1260	300	920	1538	1900
46SV6/2AG220T	150	125	498	752	1517	90	1220	70	1260	300	920	1613	1900
66SV1/1AG040T	200	150	529	794	1635	70	1260	70	1260	300	934	1033	1273
66SV1G055T	200	150	529	794	1635	70	1260	70	1260	300	934	1109	1273
66SV2/2AG075T	200	150	529	794	1635	70	1260	70	1260	300	934	1191	1273
66SV2/1AG110T	200	150	529	794	1635	70	1260	70	1260	300	934	1287	1650
66SV2G110T	200	150	529	794	1635	70	1260	70	1260	300	934	1287	1650
66SV3/2AG150T	200	150	529	794	1635	70	1260	70	1260	300	934	1443	1650
66SV3/1AG150T	200	150	529	794	1635	70	1260	70	1260	300	934	1443	1650
66SV3G185T	200	150	529	794	1635	70	1260	70	1260	300	934	1443	1900
66SV4/2AG185T	200	150	529	794	1635	70	1260	70	1260	300	934	1533	1900
66SV4/1AG220T	200	150	529	794	1635	70	1260	70	1260	300	934	1533	1900
66SV4G220T	200	150	529	794	1635	70	1260	70	1260	300	934	1533	1900
92SV1/1AG055T	200	200	529	819	1688	70	1260	70	1260	300	960	1109	1273
92SV1G075T	200	200	529	819	1688	70	1260	70	1260	300	960	1101	1273
92SV2/2AG110T	200	200	529	819	1688	70	1260	70	1260	300	960	1287	1900
92SV2G150T	200	200	529	819	1688	70	1260	70	1260	300	960	1353	1900
92SV3/2AG185T	200	200	529	819	1688	70	1260	70	1260	300	960	1443	1900
92SV3G220T	200	200	529	819	1688	70	1260	70	1260	300	960	1443	1900

Dimensions in mm. ± 10 mm tolerance range.

gs30_sv46_e_td16

THREE ELECTRIC PUMPS BOOSTER SETS GSY30 SERIES

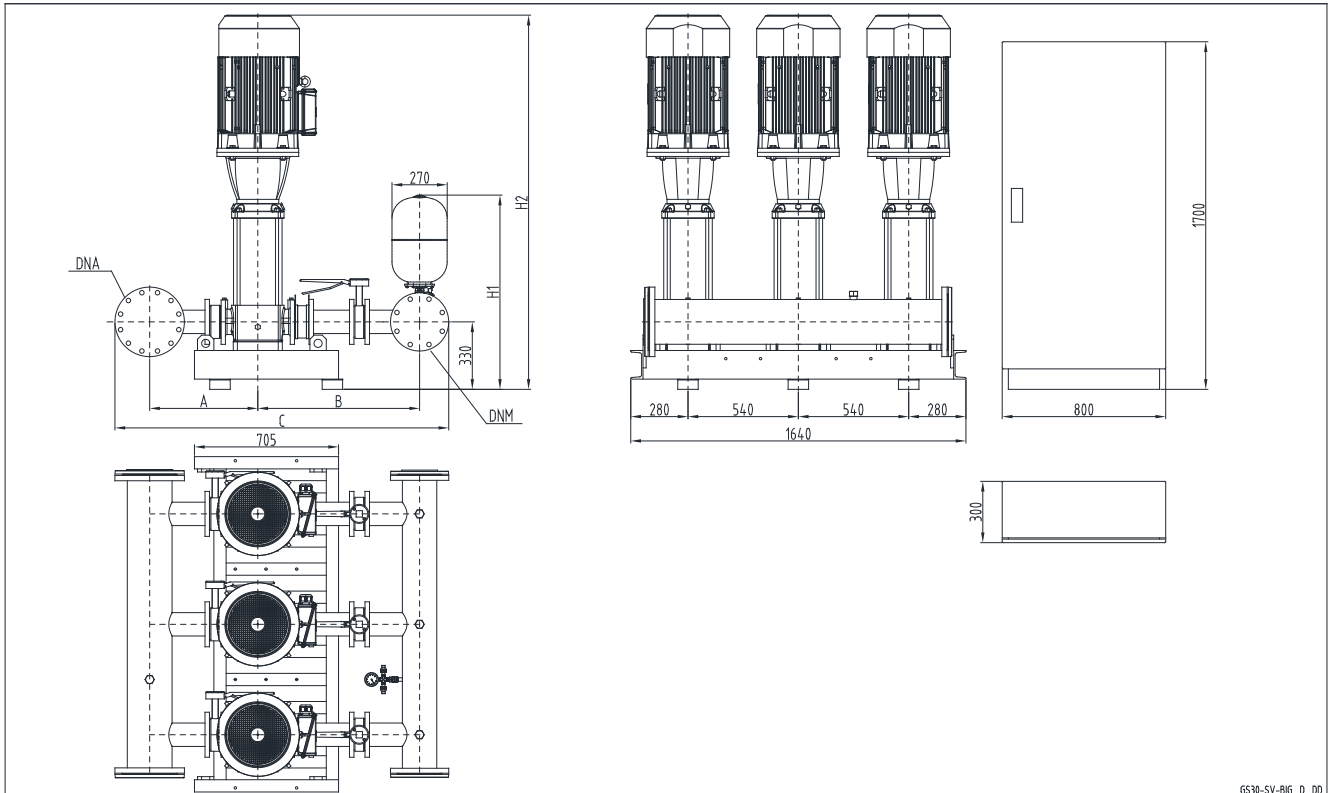

GS30-SV-BIG_D_DD

GSY30	DNA	DNM	A	B	C	H1	H2
SV6605/2F300T	200	150	529	792	1633	954	1830
SV6605/1F300T	200	150	529	792	1633	954	1830
SV6605F300T	200	150	529	792	1633	954	1830
SV9204/2F300T	200	200	529	819	1688	990	1740
SV9204F300T	200	200	529	819	1688	990	1740
SV9205/2F370T	200	200	529	819	1688	990	1830

Dimensions in mm. ± 10 mm tolerance range.

gs30_sv-big_d_td

THREE ELECTRIC PUMPS BOOSTER SETS GSD30 SERIES

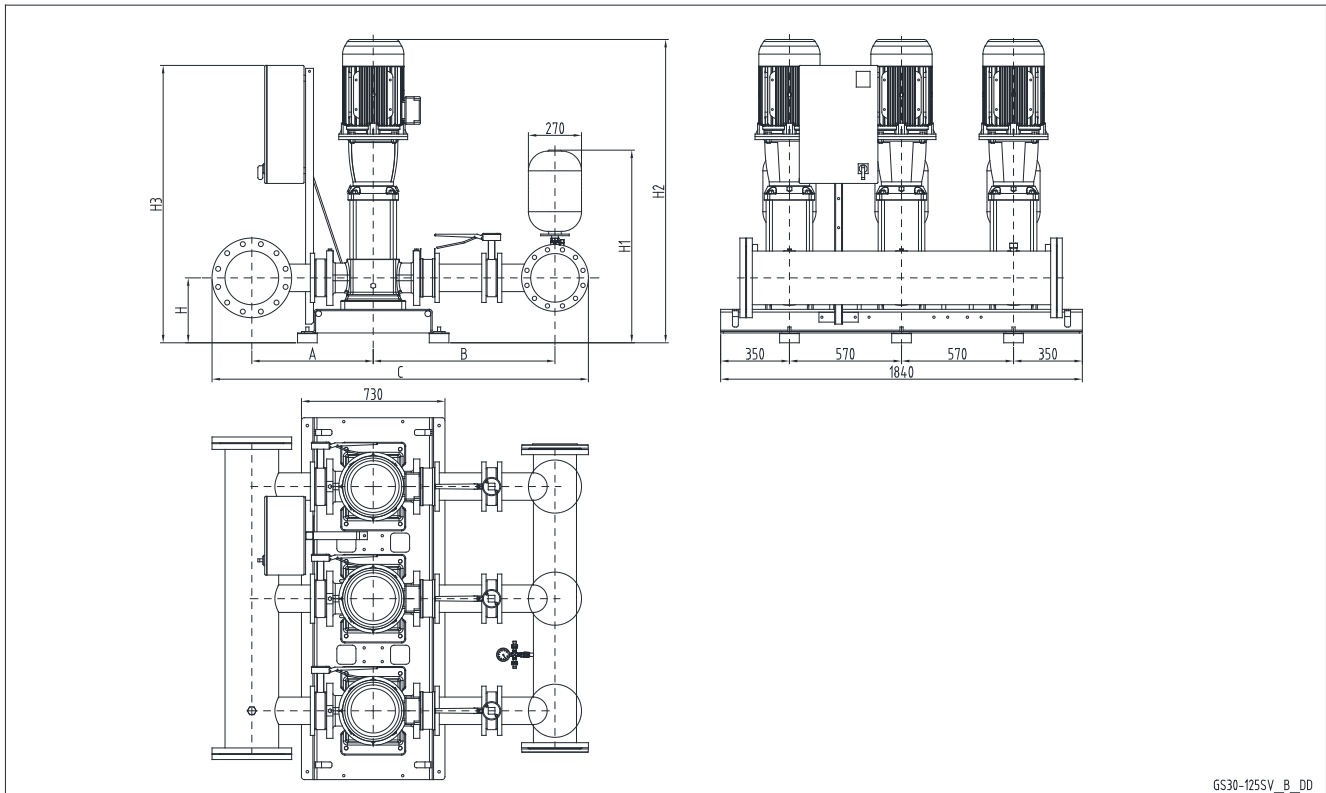

GSD30	DNA	DNM	A	B	C	D	E	F	G	H	H1	H2	H3
125SV1G075T	250	200	618	927	1917	160	1520	130	1580	330	990	1230	1410
125SV2G150T	250	200	618	927	1917	160	1520	130	1580	330	990	1542	1410
125SV3G220T	250	200	618	927	1917	160	1520	130	1580	330	990	1692	1410

Dimensions in mm. ± 10 mm tolerance range.

gs30_125sv_b_td

**THREE ELECTRIC PUMPS BOOSTER SETS
GSY30 SERIES**

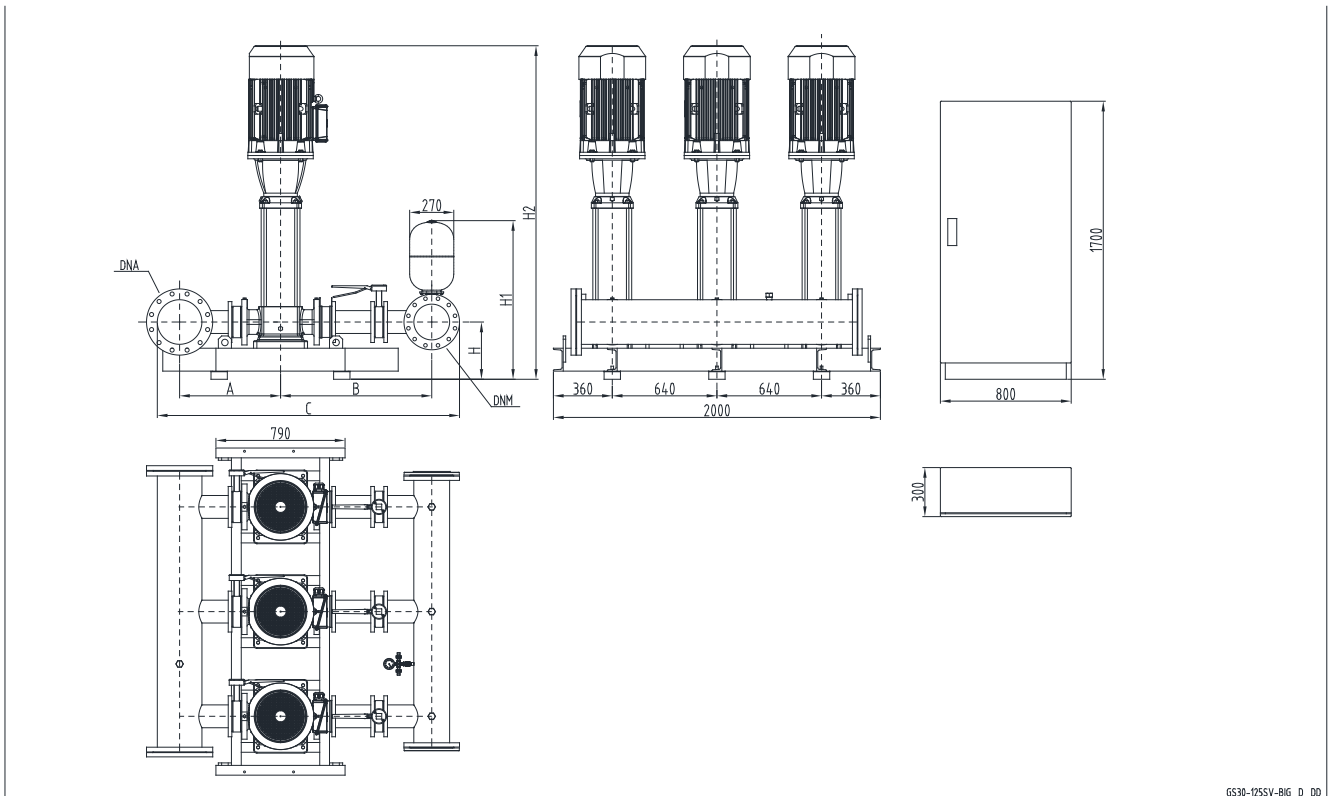

GS30-125SV-BIG_D_DD

GSY30	DNA	DNM	A	B	C	H	H1	H2
125SV4G300T	250	200	618	927	1917	350	1010	2189
125SV5G370T	250	200	618	927	1917	350	1010	2369

Dimensions in mm. ± 10 mm tolerance range.

gs30_125sv-big_c_td

PERFORMANCE CURVES

GS.../SV BOOSTER SETS SERIES OPERATING CHARACTERISTICS AT 50 Hz (SERVICE)

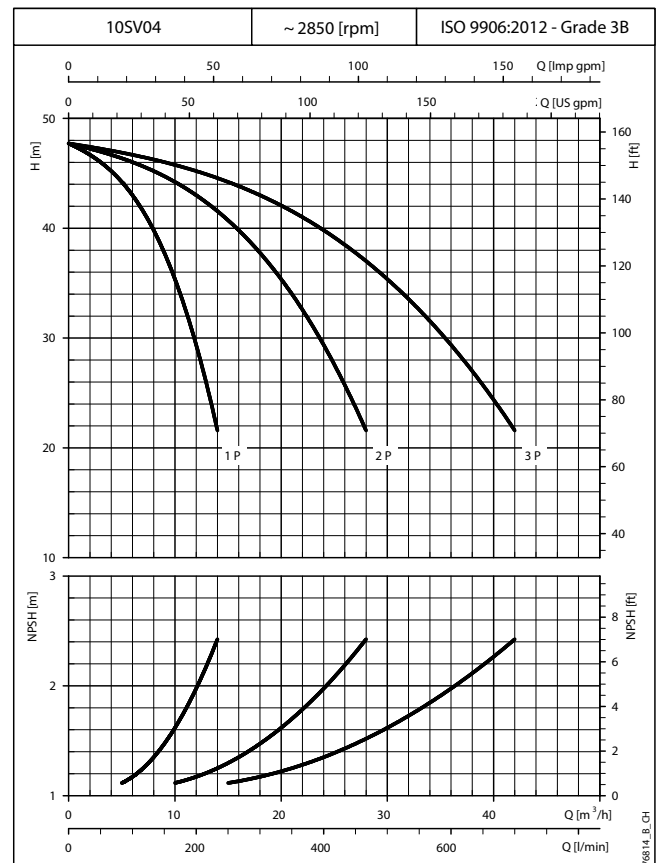
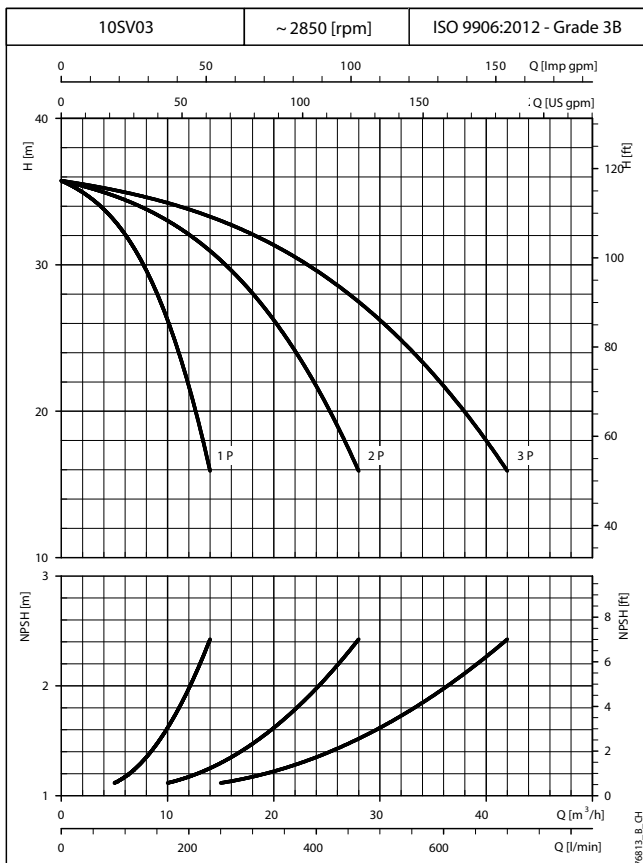
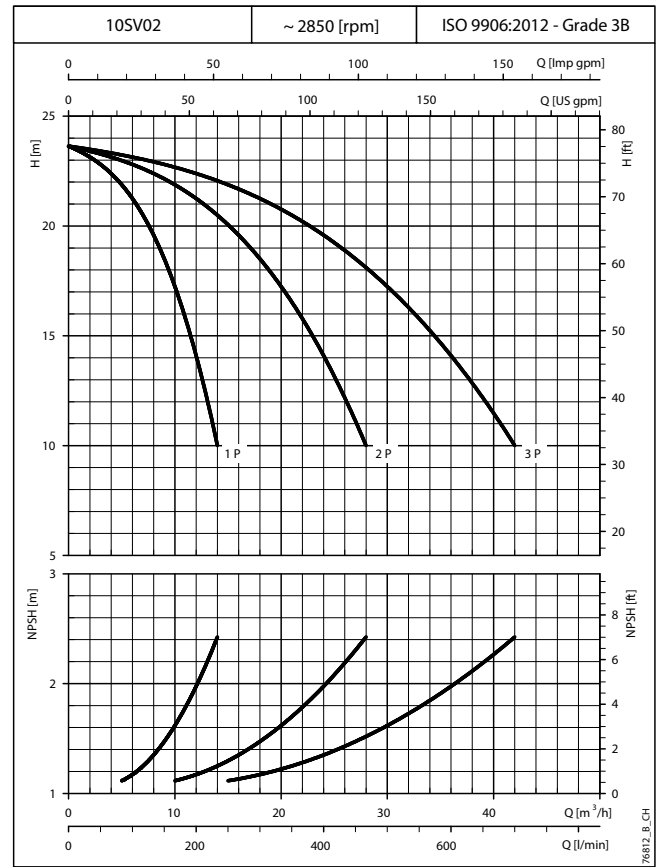
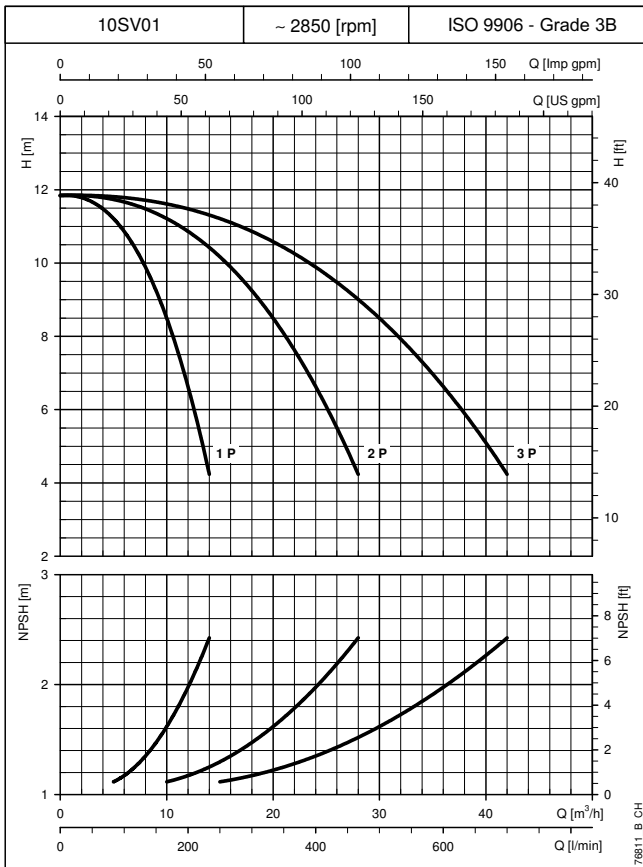

The performance curves do not take into account flow resistance in the valves and piping. The curves show the performance with one, two and three electric pumps running. These performances are valid for liquids with density $\rho = 1.0 \text{ Kg/dm}^3$ and kinematic viscosity $\nu = 1 \text{ mm}^2/\text{sec}$.
The declared NPSH values are laboratory values; for practical use we recommend increasing these values by 0,5 m.

GS.../SV BOOSTER SETS SERIES OPERATING CHARACTERISTICS AT 50 Hz (SERVICE)

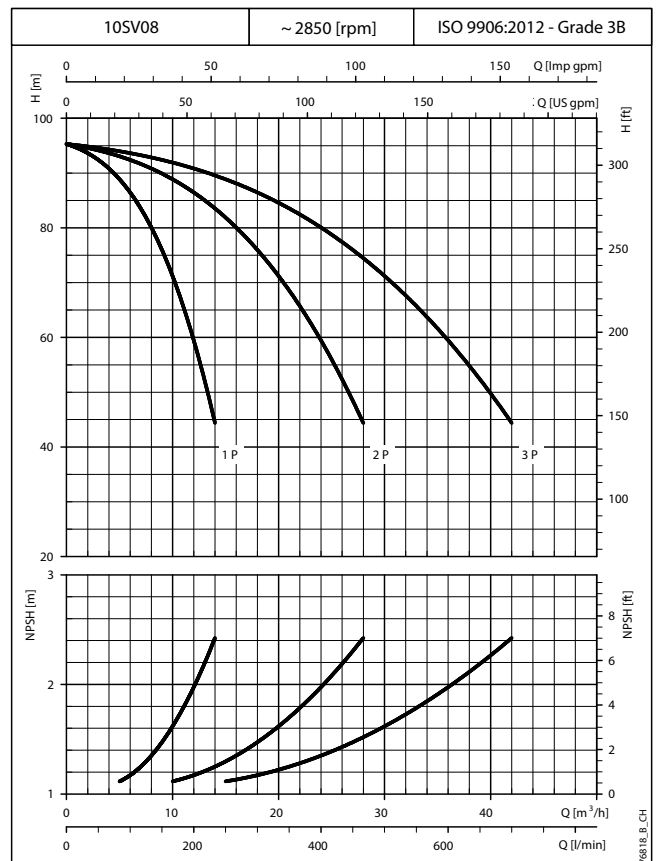
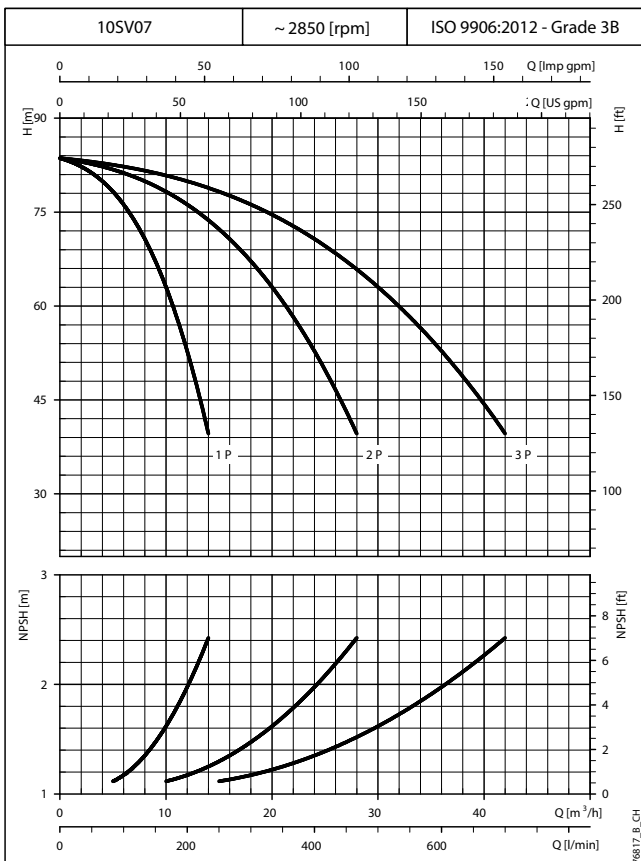
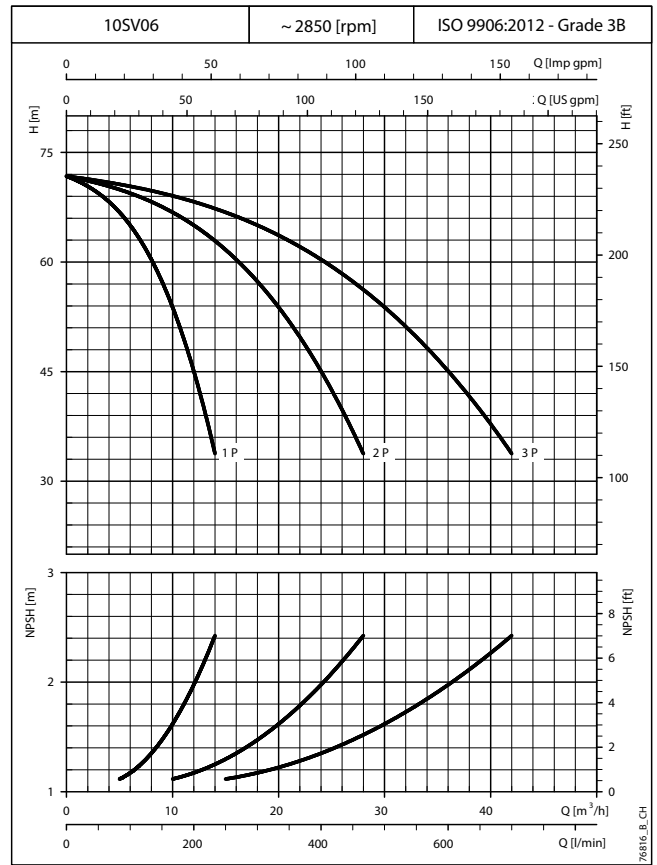
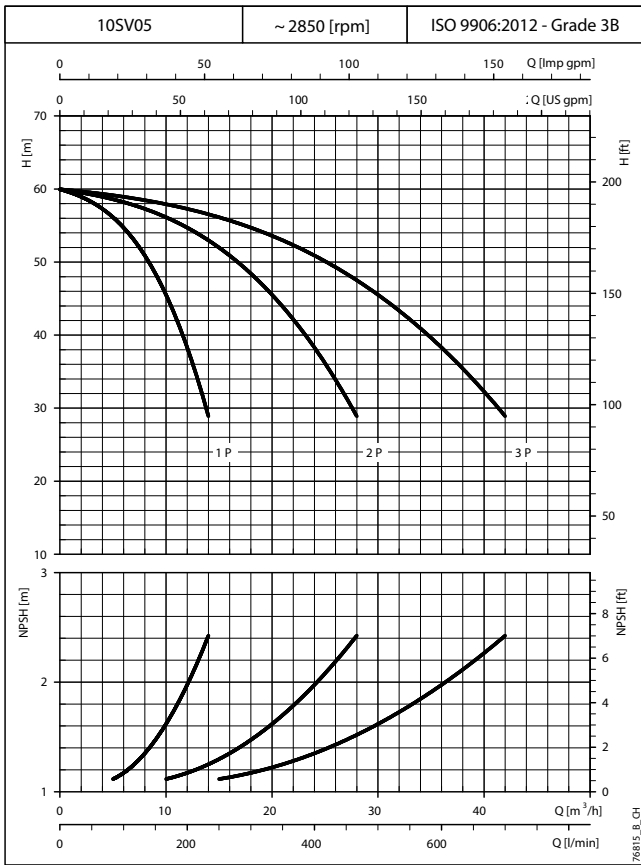

The performance curves do not take into account flow resistance in the valves and piping. The curves show the performance with one, two and three electric pumps running. These performances are valid for liquids with density $\rho = 1.0 \text{ Kg/dm}^3$ and kinematic viscosity $\nu = 1 \text{ mm}^2/\text{sec}$.
The declared NPSH values are laboratory values; for practical use we recommend increasing these values by 0,5 m.

GS.../SV BOOSTER SETS SERIES OPERATING CHARACTERISTICS AT 50 Hz (SERVICE)

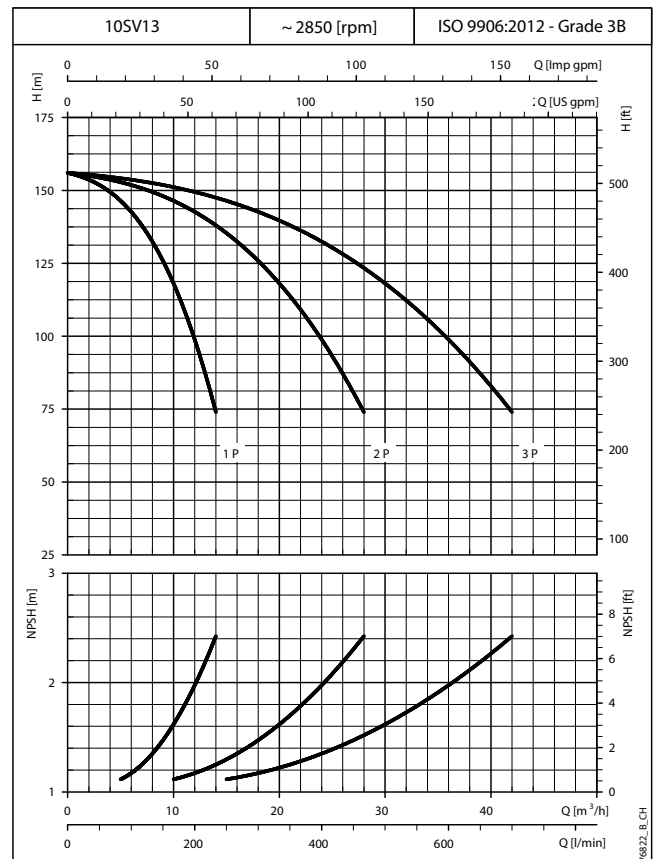
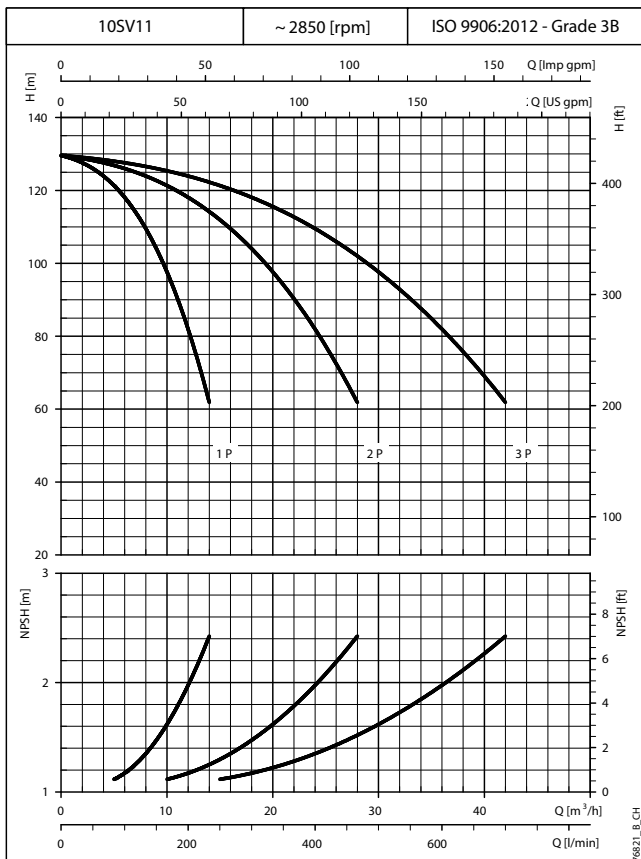
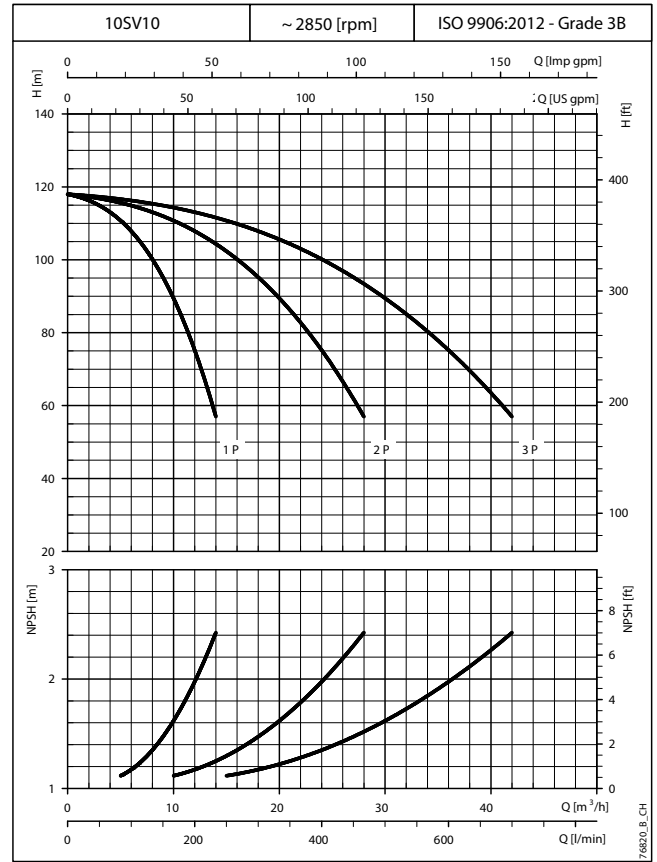
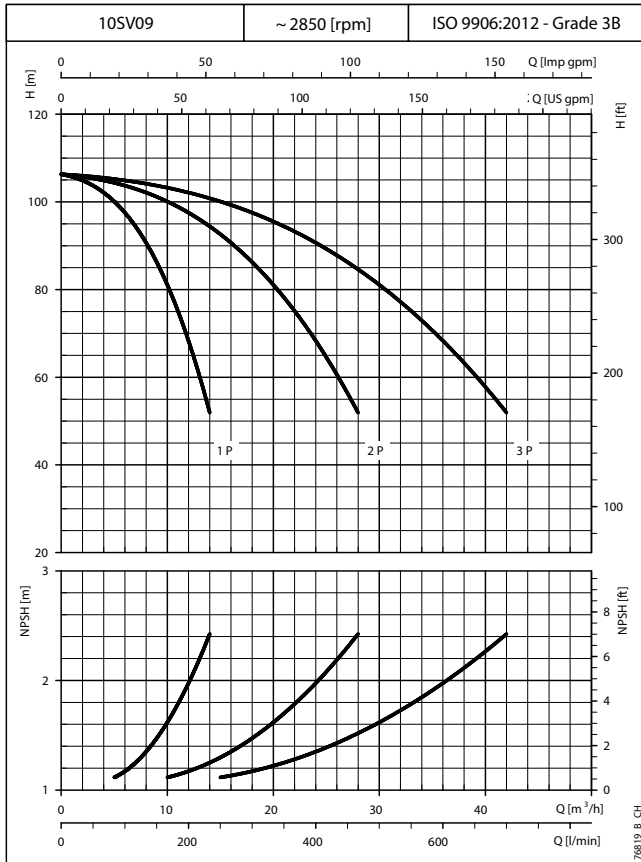

The performance curves do not take into account flow resistance in the valves and piping. The curves show the performance with one, two and three electric pumps running. These performances are valid for liquids with density $\rho = 1.0 \text{ Kg/dm}^3$ and kinematic viscosity $\nu = 1 \text{ mm}^2/\text{sec}$.
The declared NPSH values are laboratory values; for practical use we recommend increasing these values by 0,5 m.

GS.../SV BOOSTER SETS SERIES OPERATING CHARACTERISTICS AT 50 Hz (SERVICE)

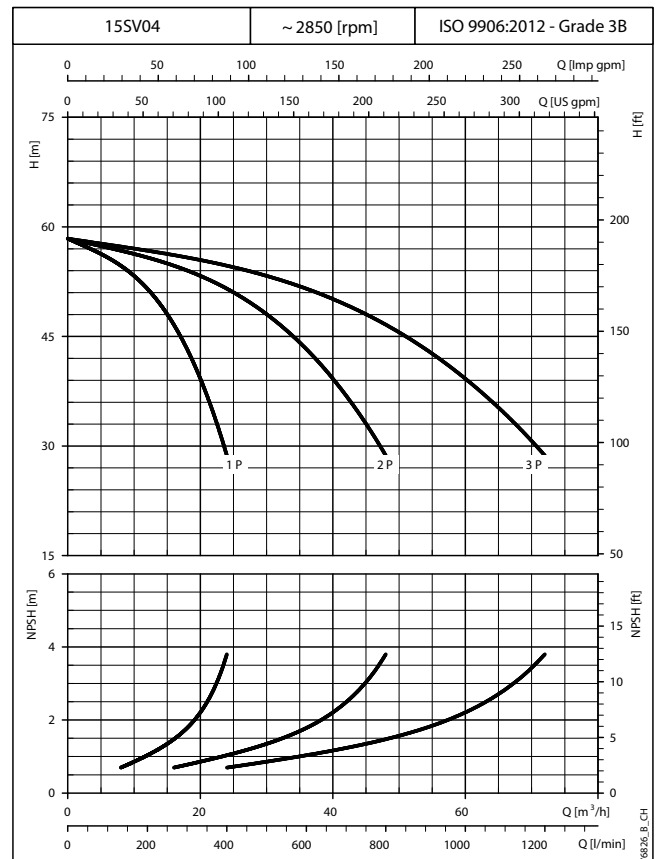
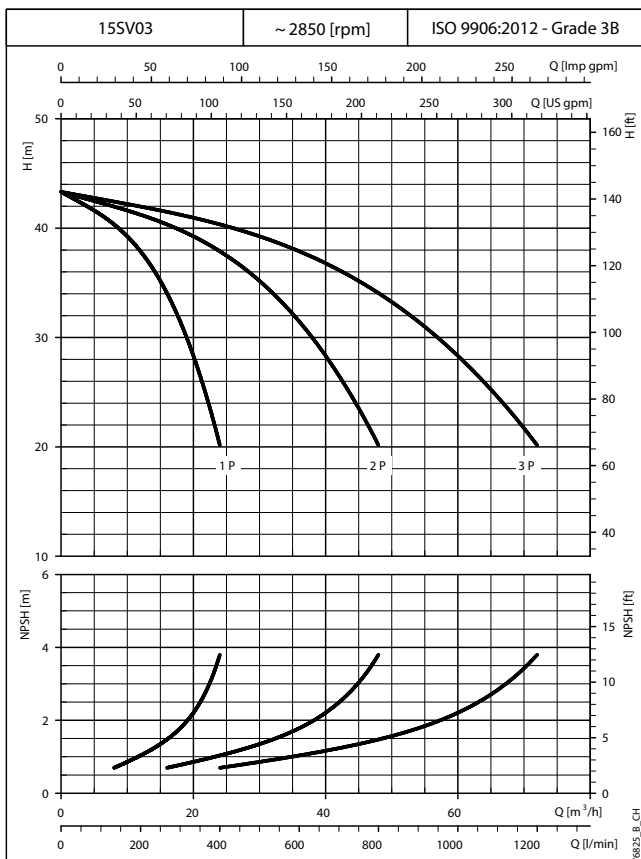
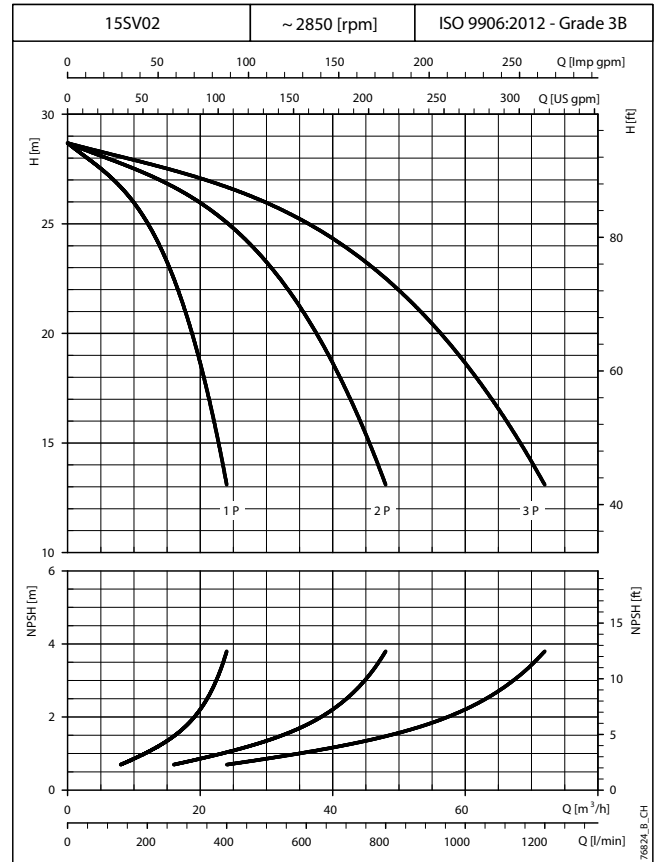
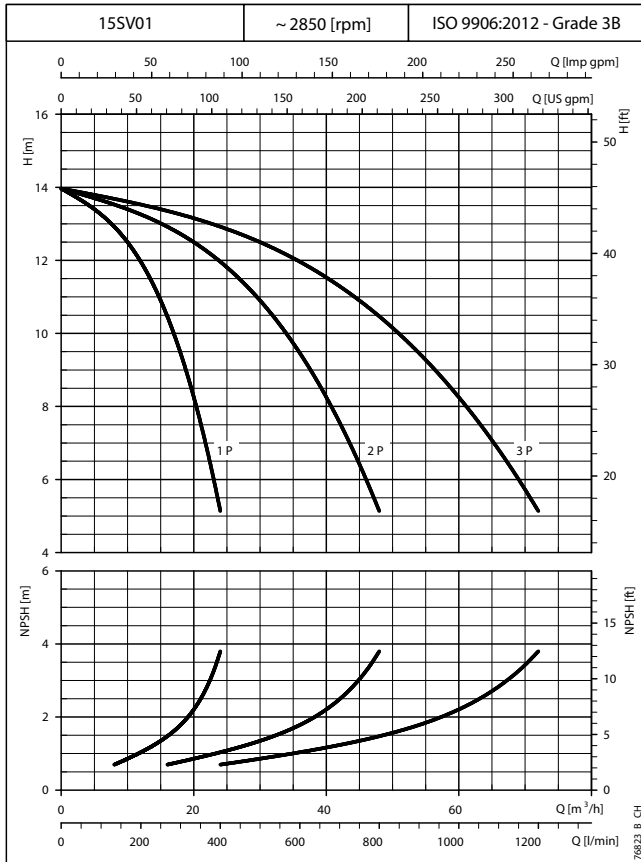

The performance curves do not take into account flow resistance in the valves and piping. The curves show the performance with one, two and three electric pumps running. These performances are valid for liquids with density $\rho = 1.0 \text{ Kg/dm}^3$ and kinematic viscosity $\nu = 1 \text{ mm}^2/\text{sec}$.
The declared NPSH values are laboratory values; for practical use we recommend increasing these values by 0,5 m.

GS.../SV BOOSTER SETS SERIES OPERATING CHARACTERISTICS AT 50 Hz (SERVICE)

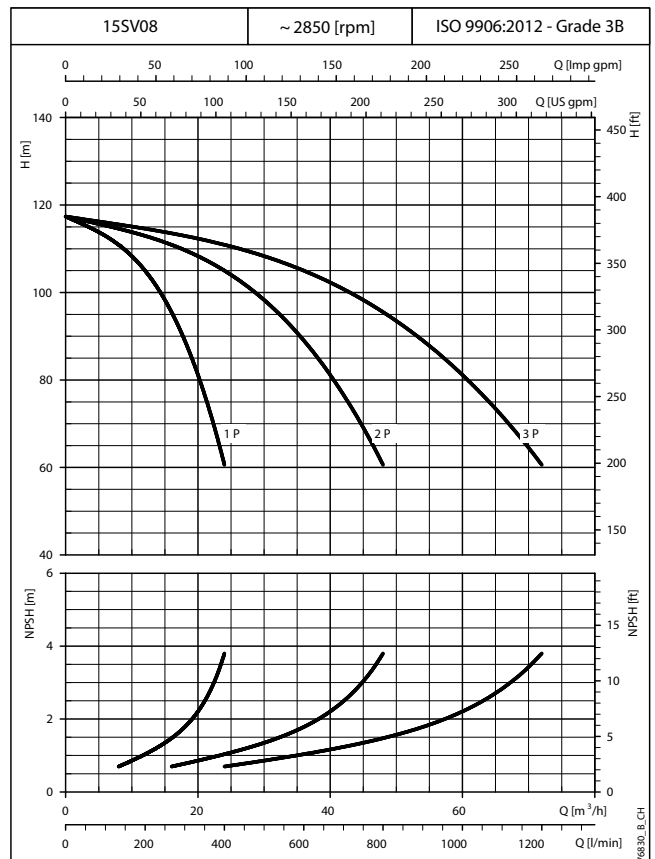
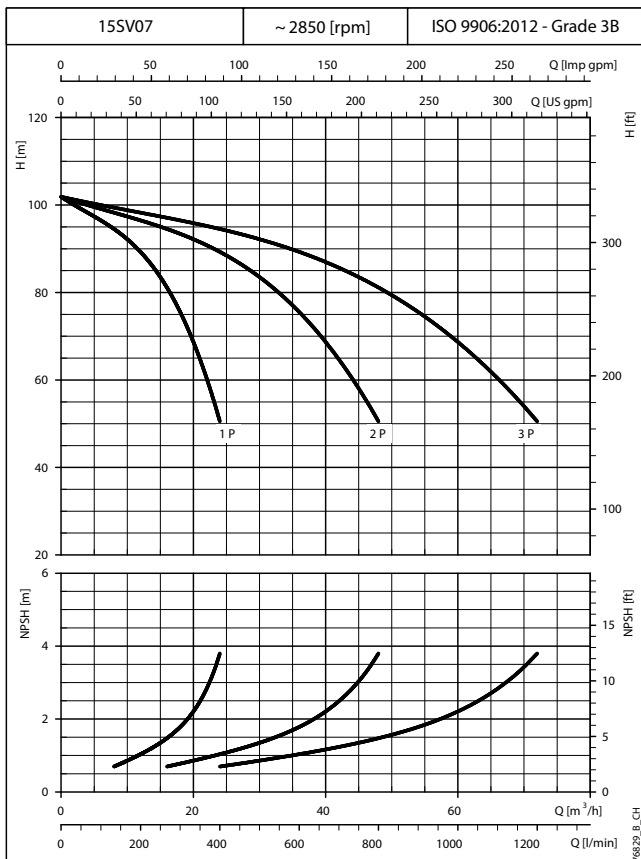
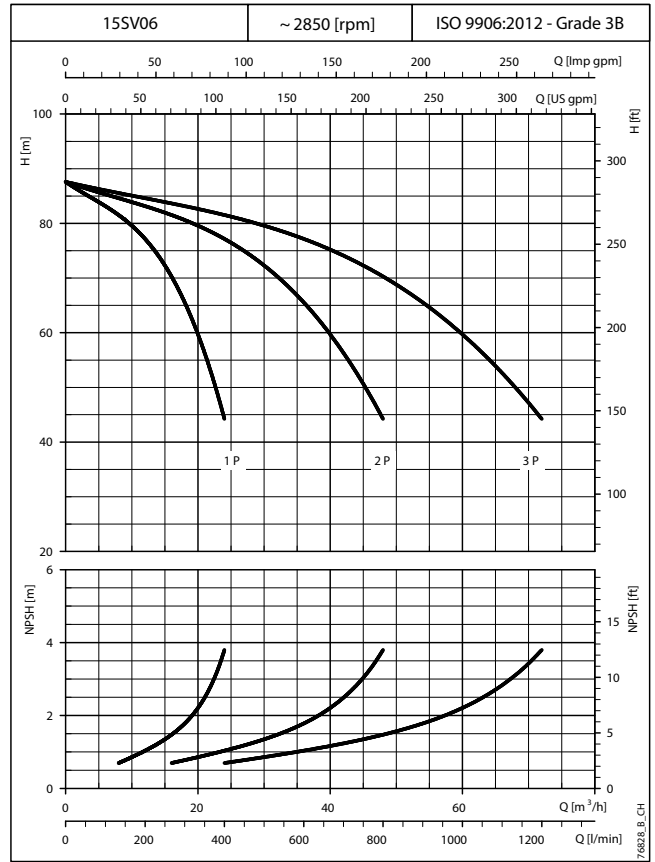
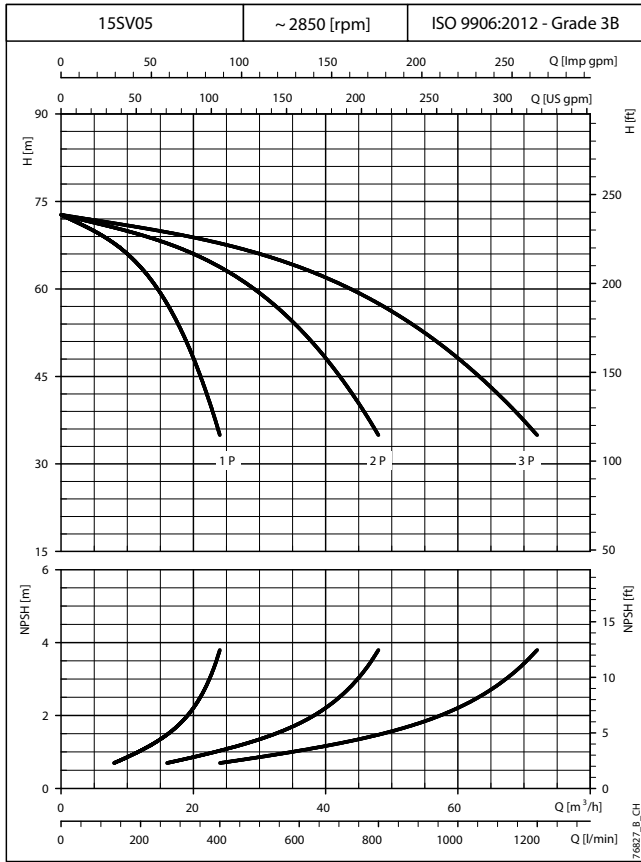

The performance curves do not take into account flow resistance in the valves and piping. The curves show the performance with one, two and three electric pumps running. These performances are valid for liquids with density $\rho = 1.0 \text{ Kg/dm}^3$ and kinematic viscosity $\nu = 1 \text{ mm}^2/\text{sec}$.
The declared NPSH values are laboratory values; for practical use we recommend increasing these values by 0,5 m.

GS.../SV BOOSTER SETS SERIES OPERATING CHARACTERISTICS AT 50 Hz (SERVICE)

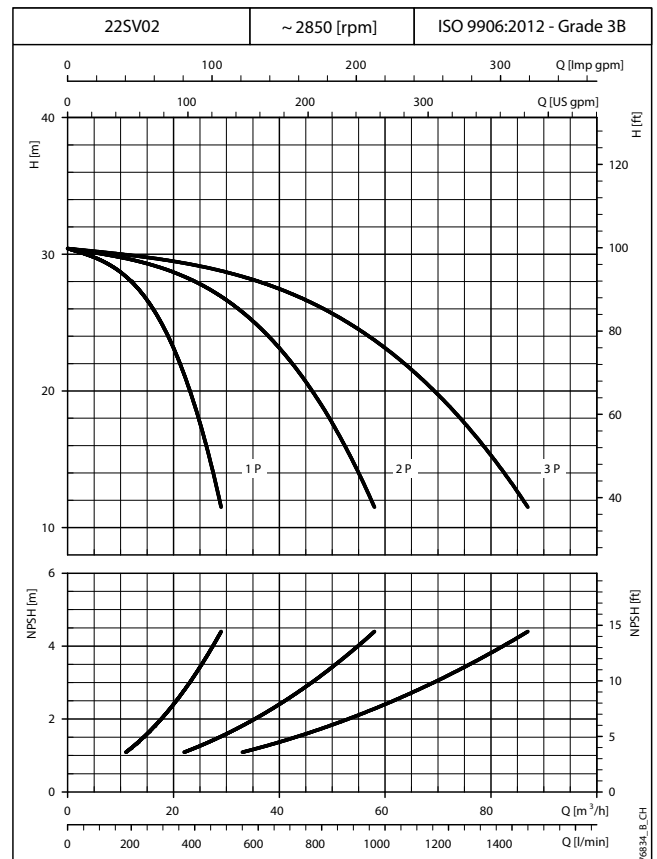
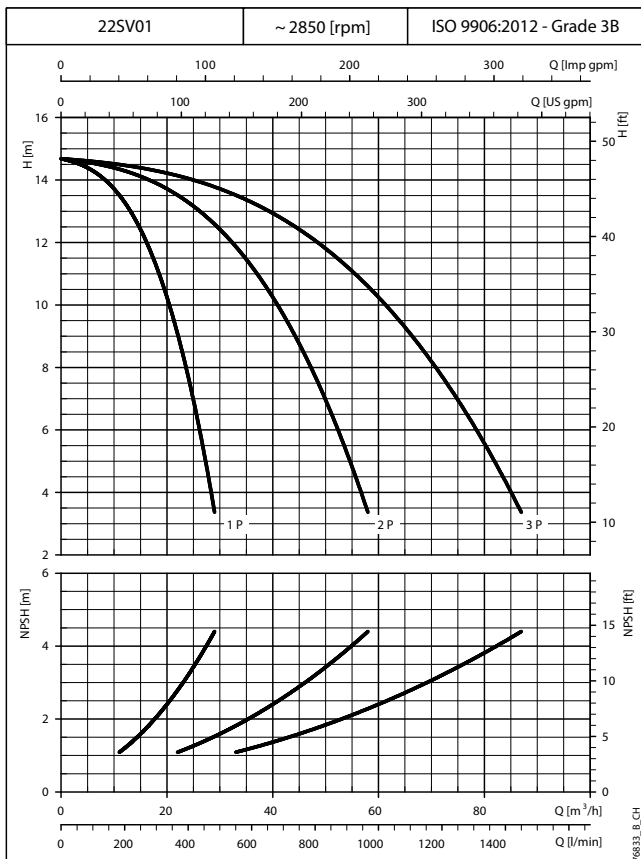
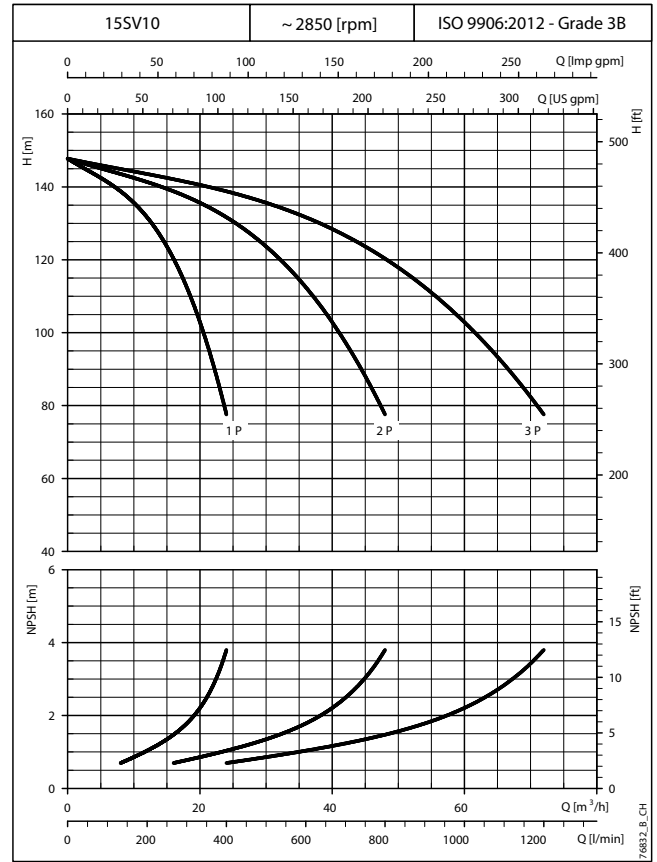
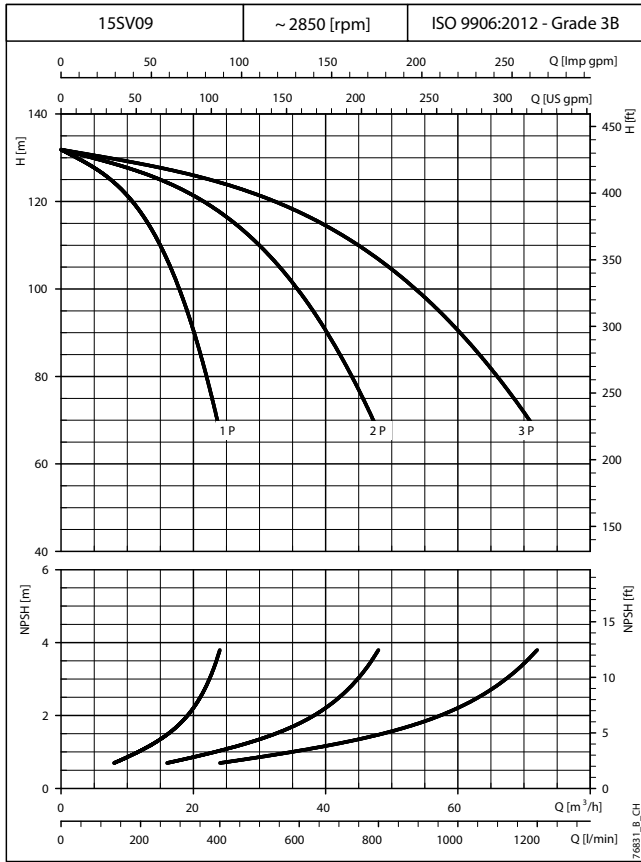

The performance curves do not take into account flow resistance in the valves and piping. The curves show the performance with one, two and three electric pumps running. These performances are valid for liquids with density $\rho = 1.0 \text{ Kg/dm}^3$ and kinematic viscosity $\nu = 1 \text{ mm}^2/\text{sec}$. The declared NPSH values are laboratory values; for practical use we recommend increasing these values by 0,5 m.

GS.../SV BOOSTER SETS SERIES OPERATING CHARACTERISTICS AT 50 Hz (SERVICE)

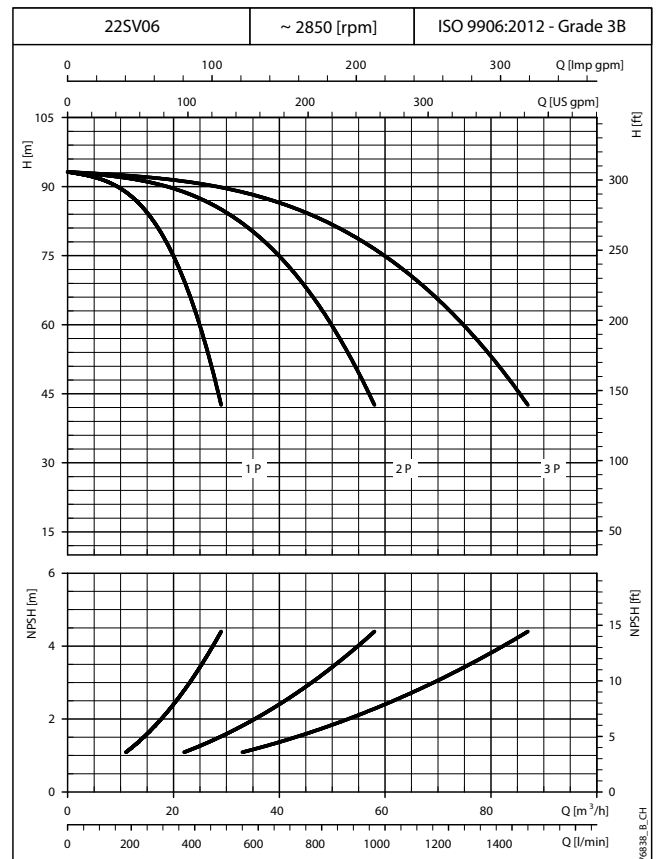
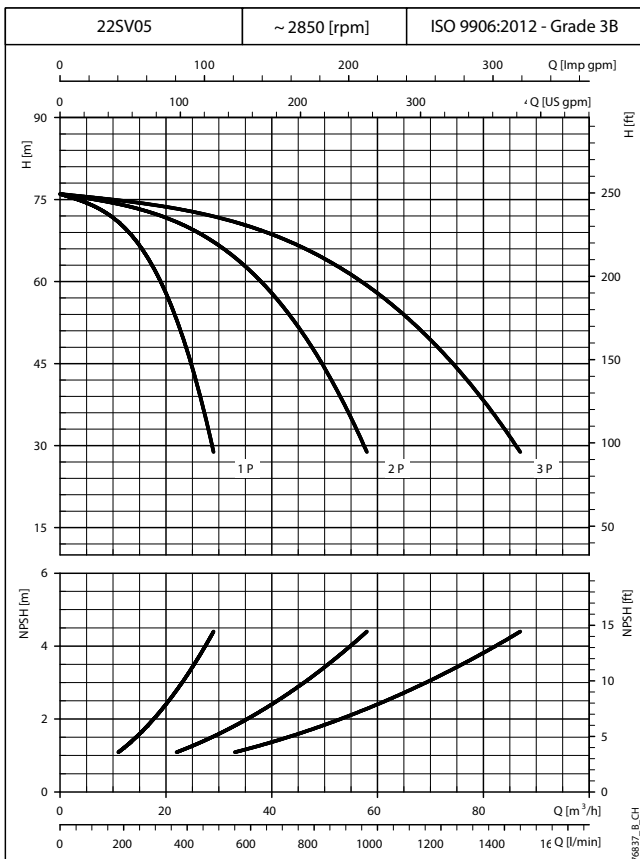
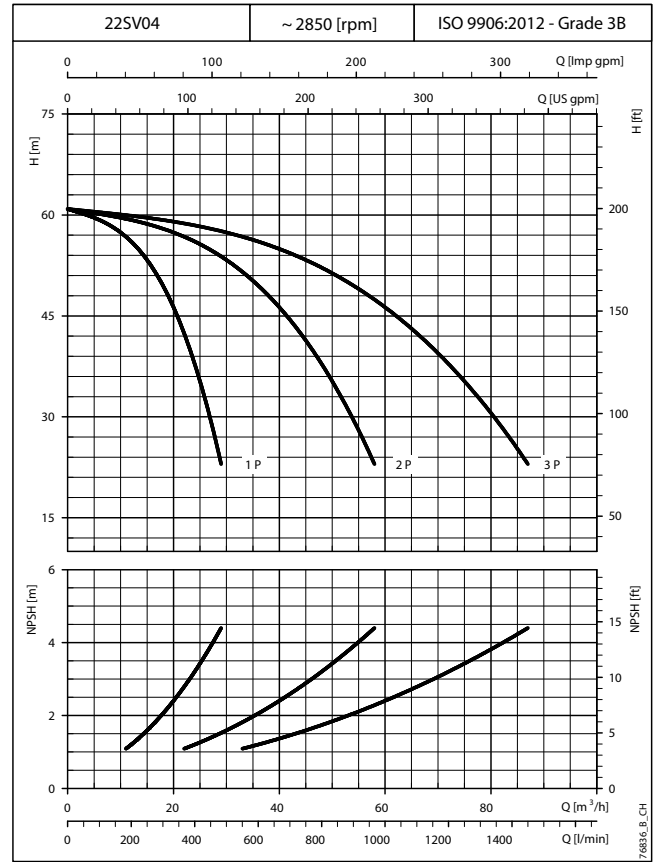
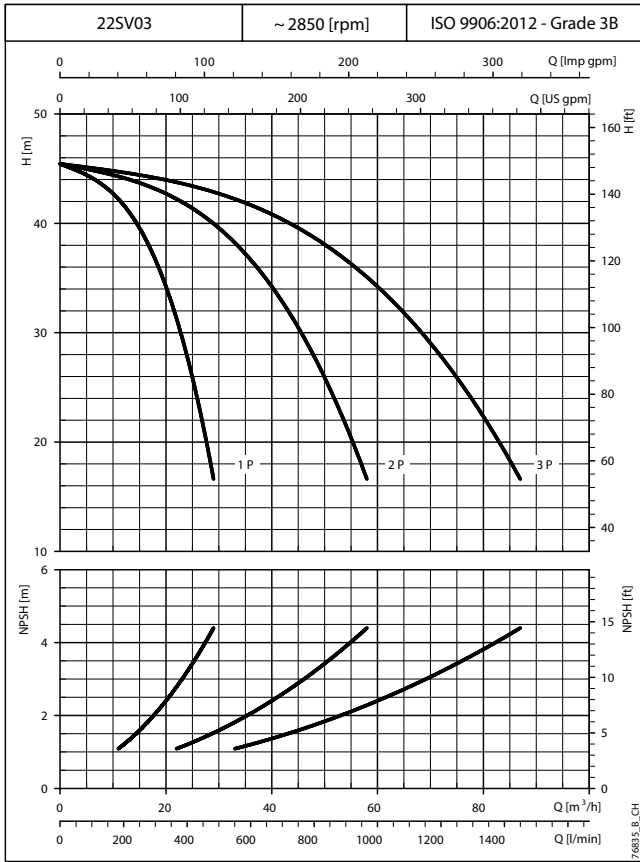

The performance curves do not take into account flow resistance in the valves and piping. The curves show the performance with one, two and three electric pumps running. These performances are valid for liquids with density $\rho = 1.0 \text{ Kg/dm}^3$ and kinematic viscosity $\nu = 1 \text{ mm}^2/\text{sec}$.
The declared NPSH values are laboratory values; for practical use we recommend increasing these values by 0,5 m.

GS.../SV BOOSTER SETS SERIES OPERATING CHARACTERISTICS AT 50 Hz (SERVICE)

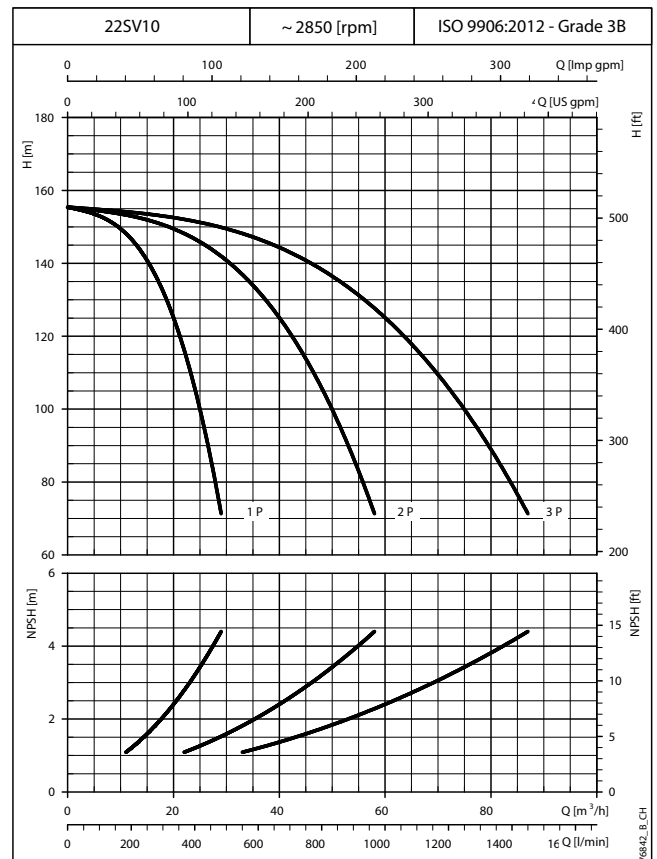
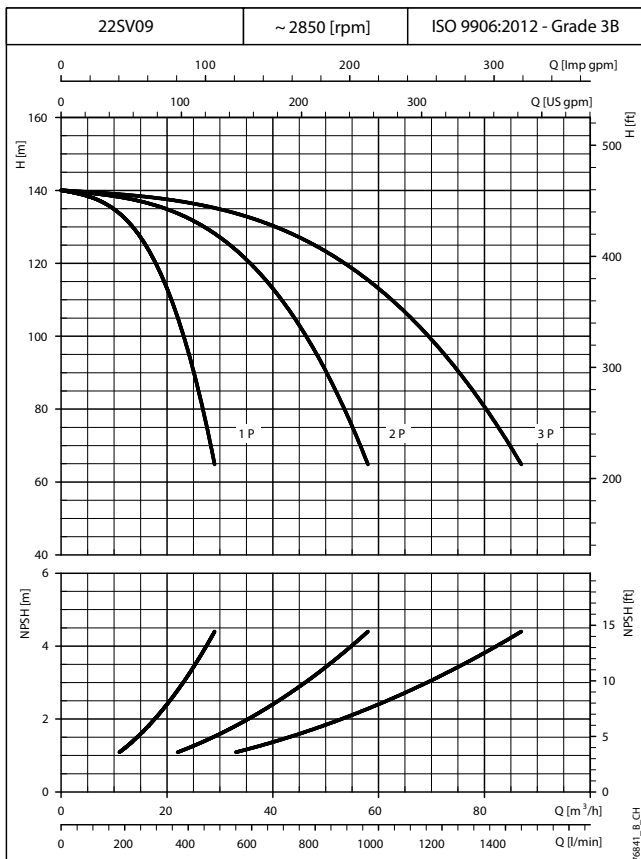
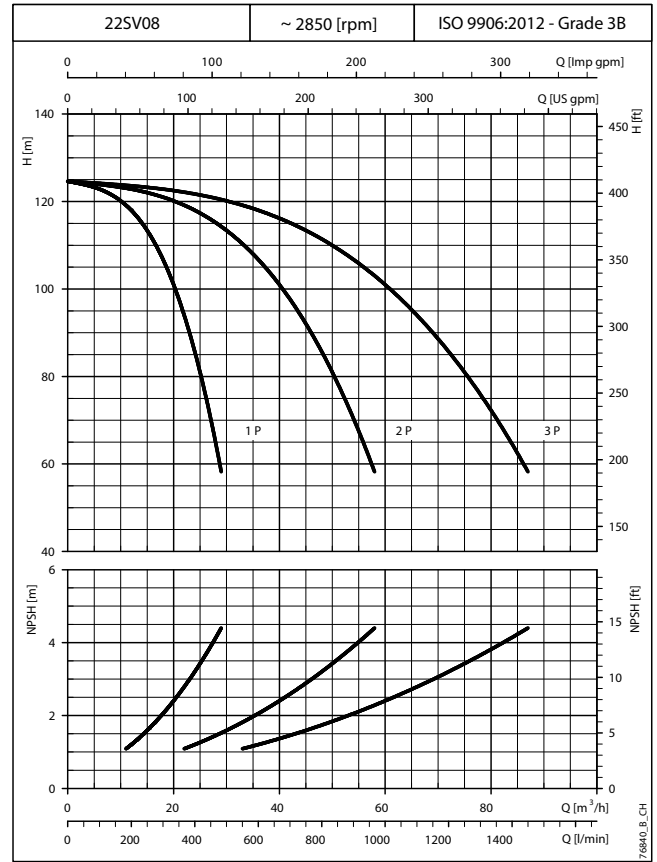
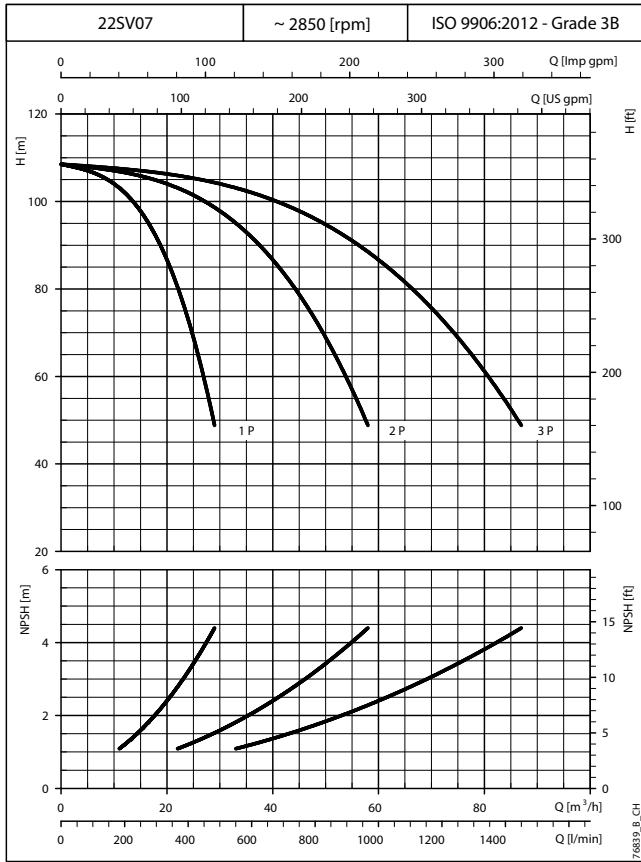

The performance curves do not take into account flow resistance in the valves and piping. The curves show the performance with one, two and three electric pumps running. These performances are valid for liquids with density $\rho = 1.0 \text{ Kg/dm}^3$ and kinematic viscosity $\nu = 1 \text{ mm}^2/\text{sec}$. The declared NPSH values are laboratory values; for practical use we recommend increasing these values by 0,5 m.

GS.../SV BOOSTER SETS SERIES OPERATING CHARACTERISTICS AT 50 Hz (SERVICE)

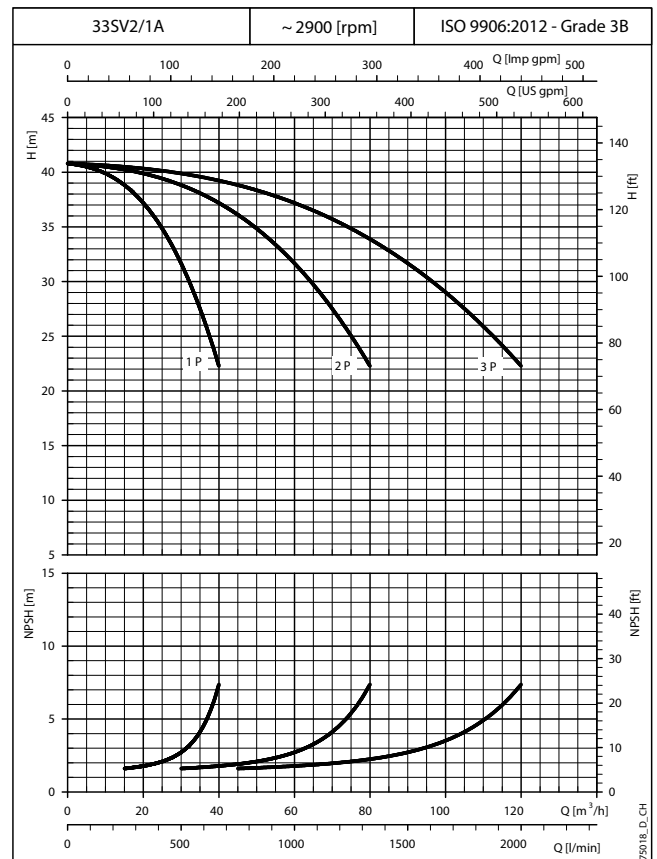
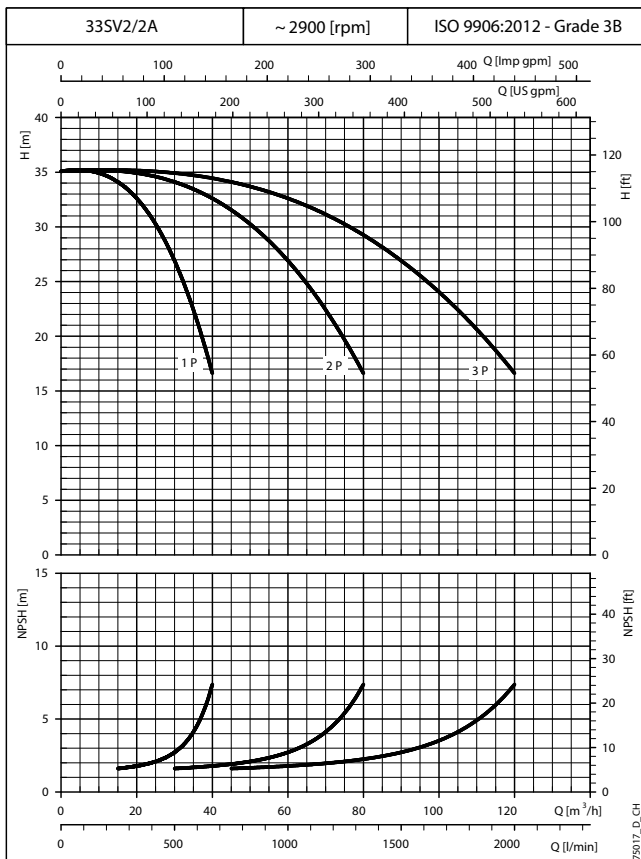
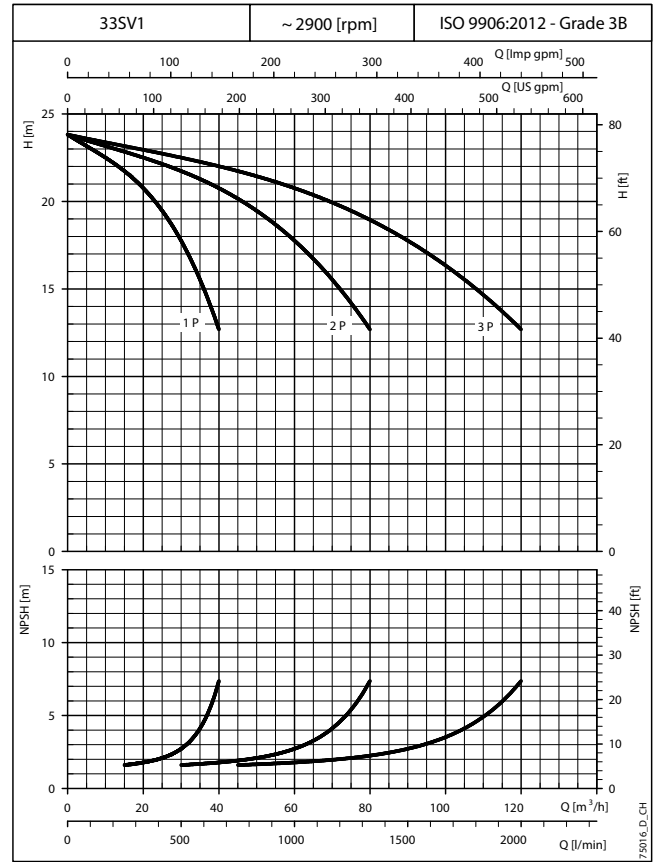
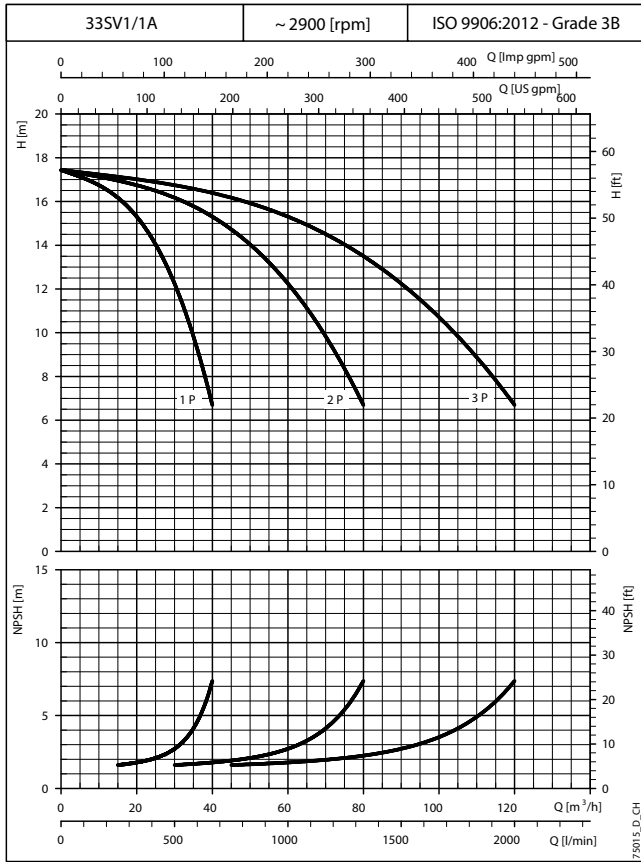

The performance curves do not take into account flow resistance in the valves and piping. The curves show the performance with one, two and three electric pumps running. These performances are valid for liquids with density $\rho = 1.0 \text{ Kg/dm}^3$ and kinematic viscosity $\nu = 1 \text{ mm}^2/\text{sec}$.

The declared NPSH values are laboratory values; for practical use we recommend increasing these values by 0,5 m.

GS.../SV BOOSTER SETS SERIES OPERATING CHARACTERISTICS AT 50 Hz (SERVICE)

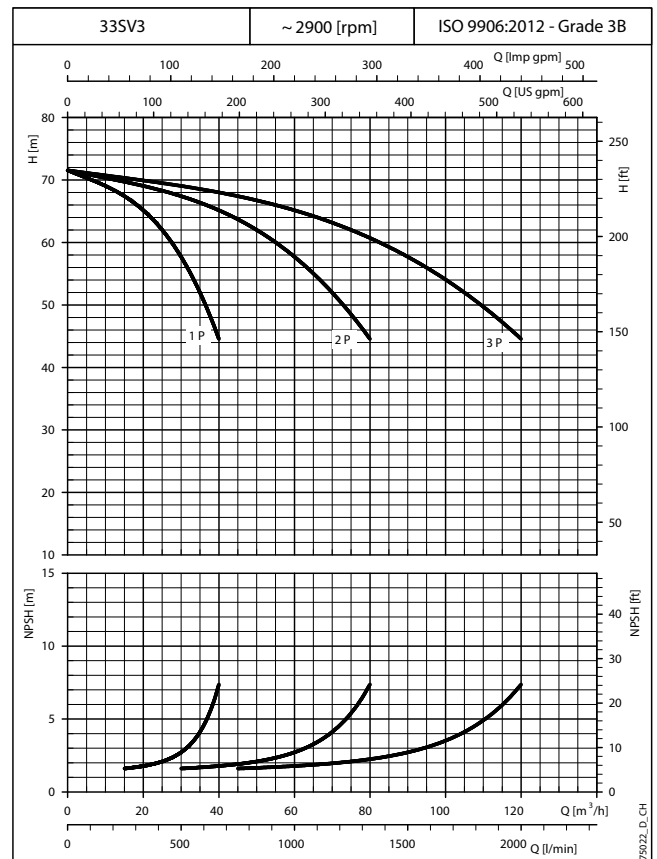
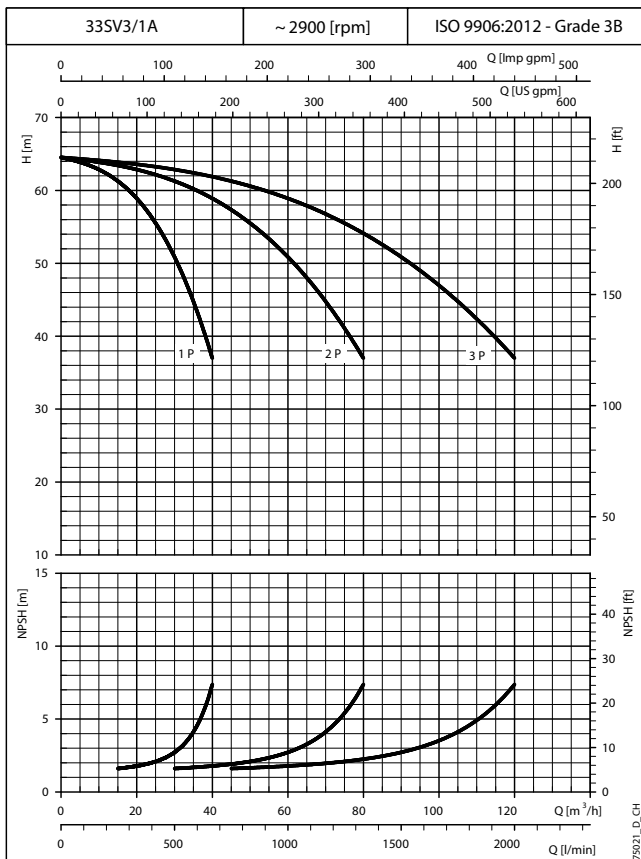
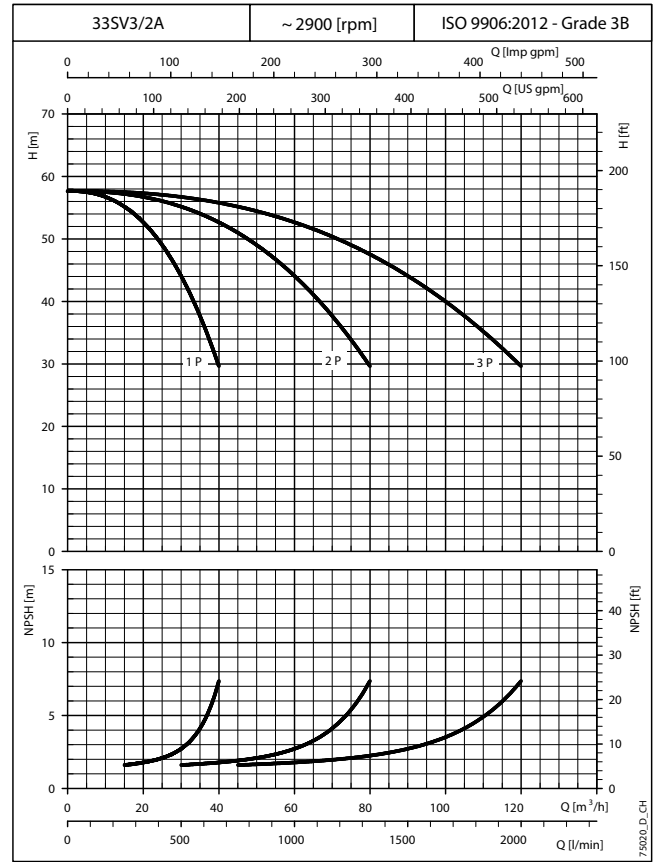
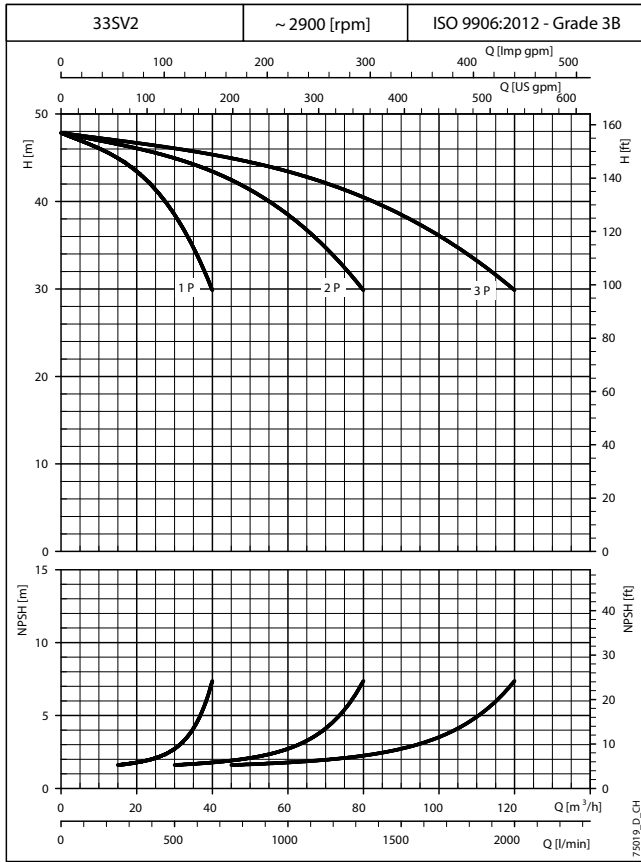

The performance curves do not take into account flow resistance in the valves and piping. The curves show the performance with one, two and three electric pumps running. These performances are valid for liquids with density $\rho = 1.0 \text{ Kg/dm}^3$ and kinematic viscosity $\nu = 1 \text{ mm}^2/\text{sec}$.

The declared NPSH values are laboratory values; for practical use we recommend increasing these values by 0,5 m.

GS.../SV BOOSTER SETS SERIES OPERATING CHARACTERISTICS AT 50 Hz (SERVICE)

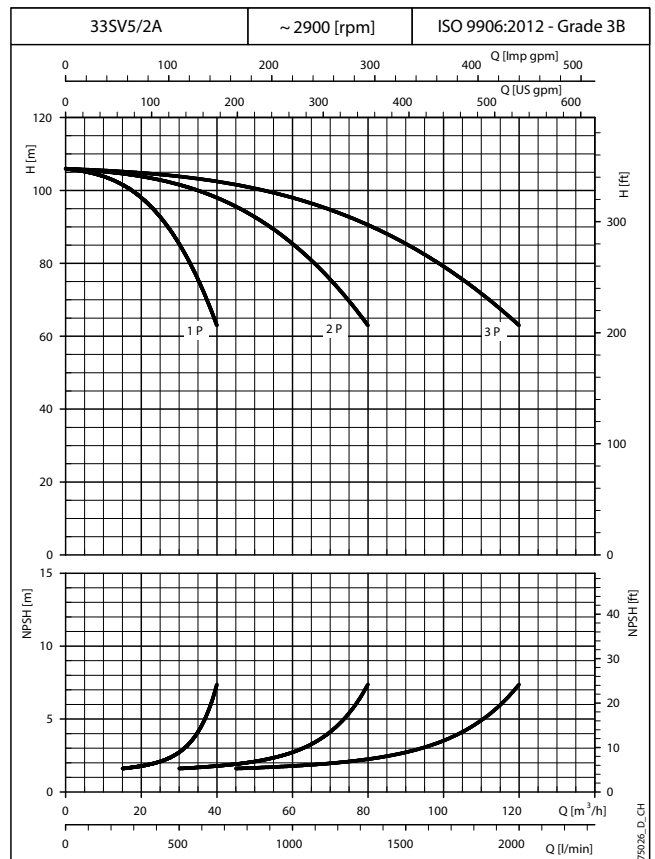
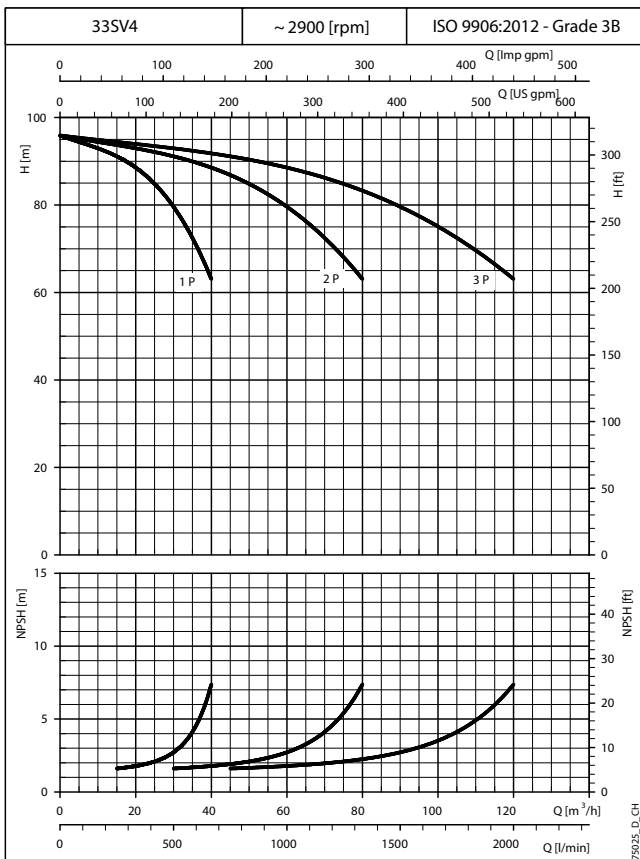
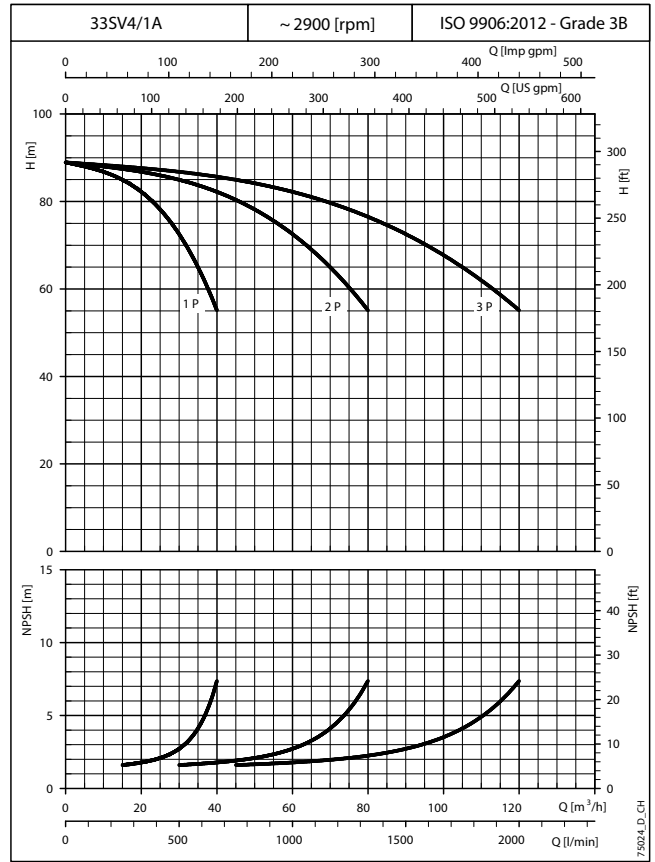
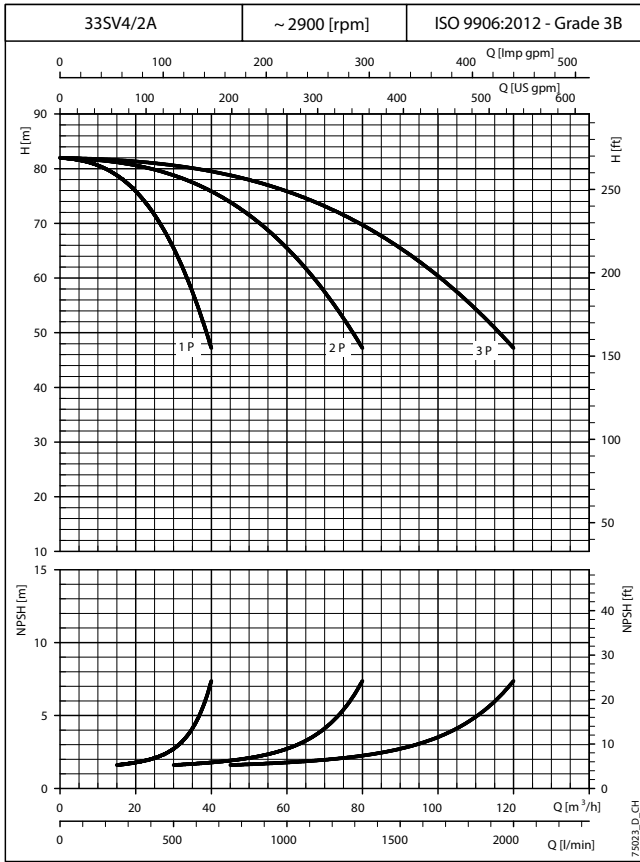

The performance curves do not take into account flow resistance in the valves and piping. The curves show the performance with one, two and three electric pumps running. These performances are valid for liquids with density $\rho = 1.0 \text{ Kg/dm}^3$ and kinematic viscosity $\nu = 1 \text{ mm}^2/\text{sec}$. The declared NPSH values are laboratory values; for practical use we recommend increasing these values by 0,5 m.

GS.../SV BOOSTER SETS SERIES OPERATING CHARACTERISTICS AT 50 Hz (SERVICE)

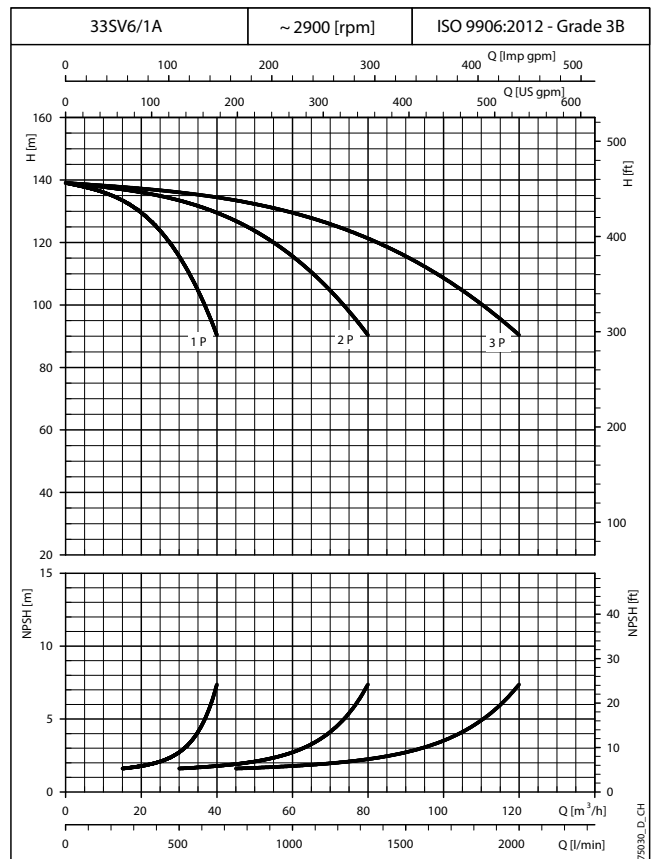
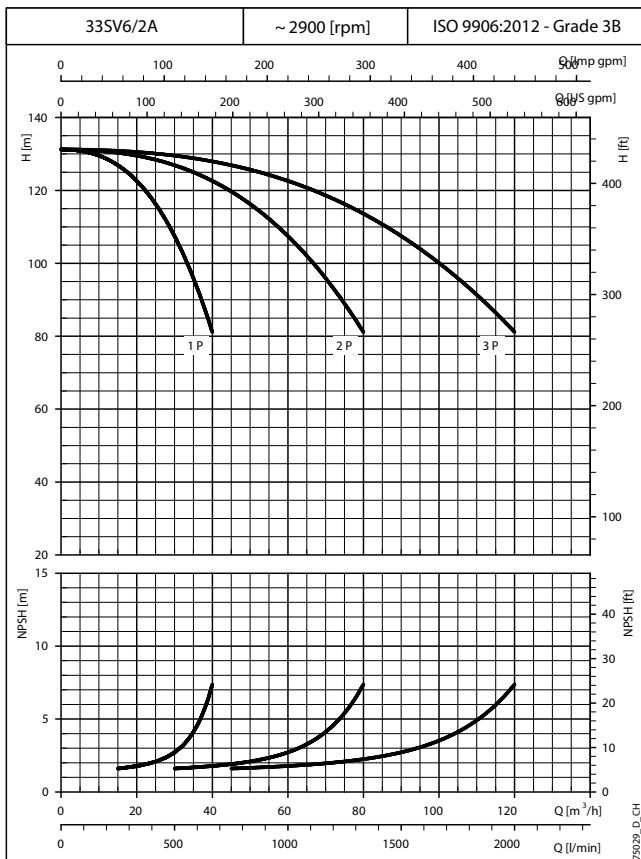
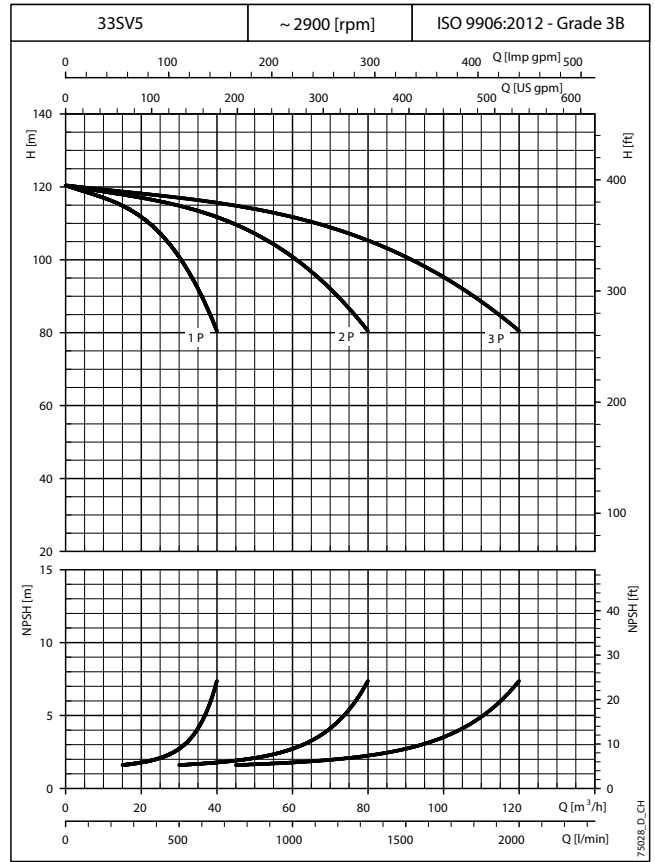
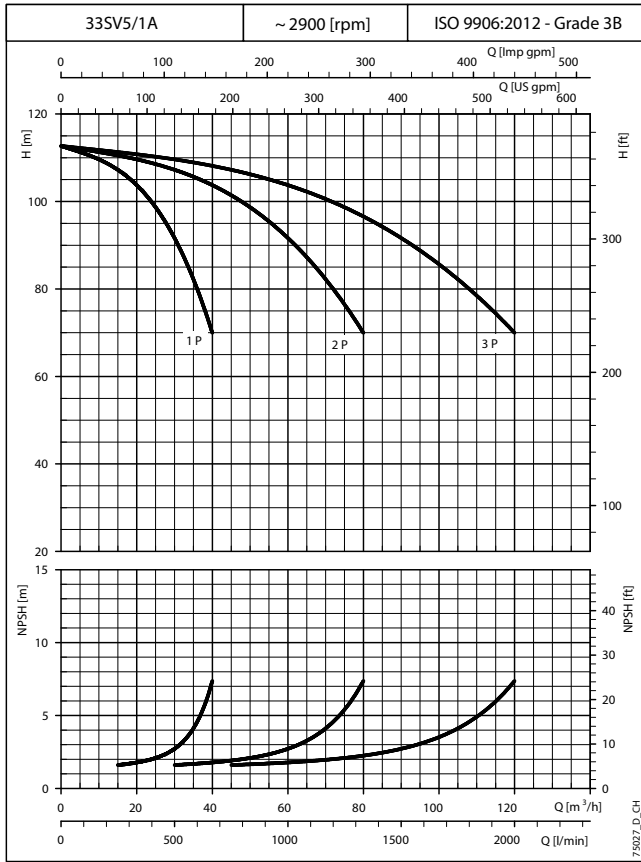

The performance curves do not take into account flow resistance in the valves and piping. The curves show the performance with one, two and three electric pumps running. These performances are valid for liquids with density $\rho = 1.0 \text{ Kg/dm}^3$ and kinematic viscosity $\nu = 1 \text{ mm}^2/\text{sec}$.

The declared NPSH values are laboratory values; for practical use we recommend increasing these values by 0,5 m.

GS.../SV BOOSTER SETS SERIES OPERATING CHARACTERISTICS AT 50 Hz (SERVICE)

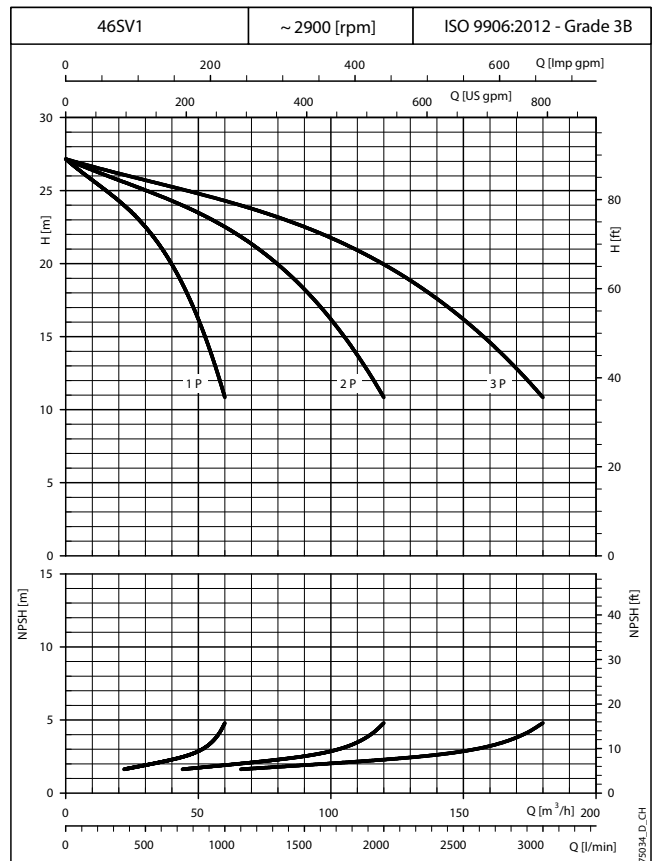
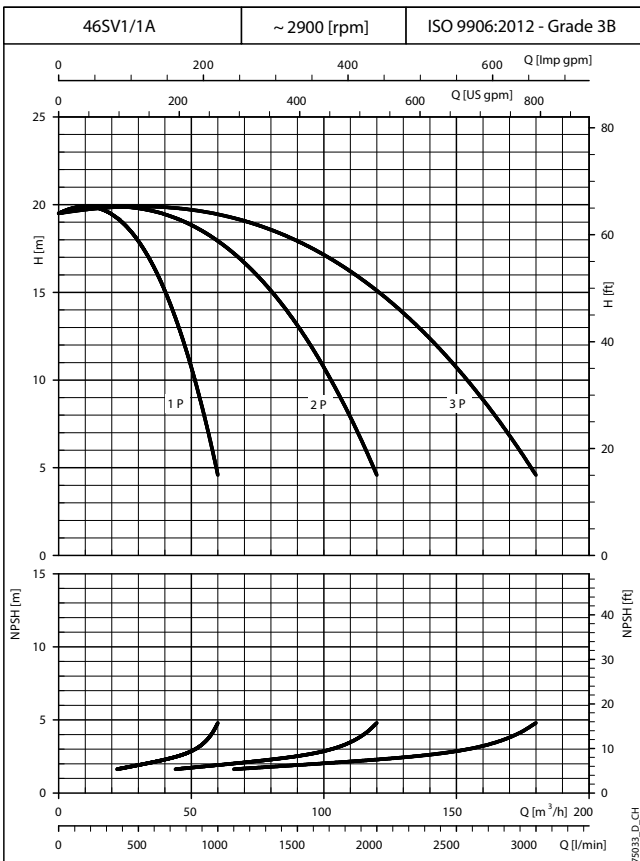
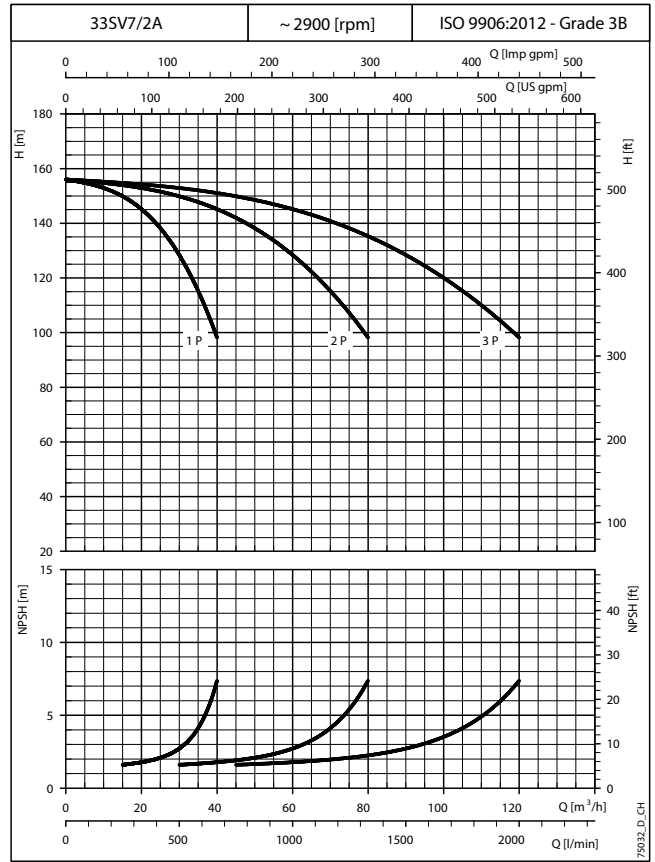
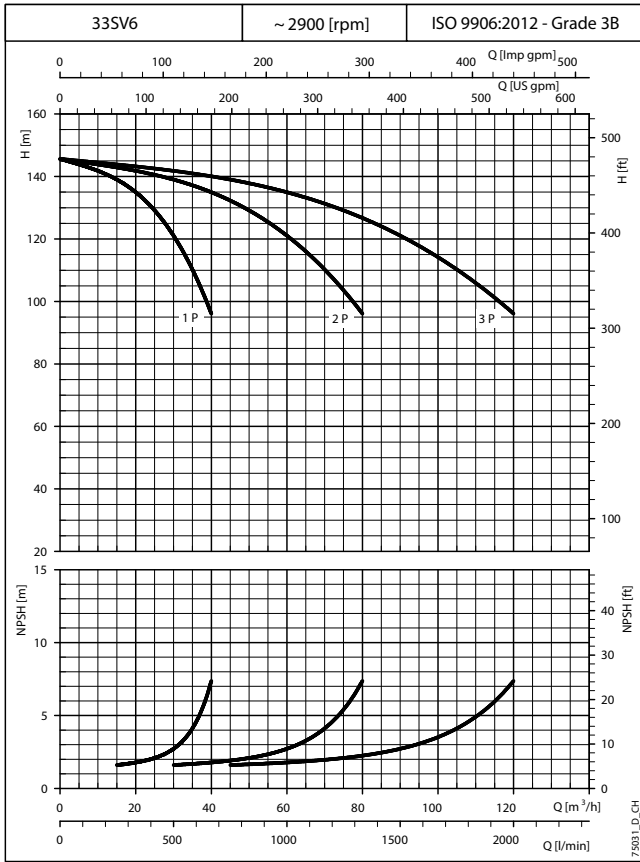

The performance curves do not take into account flow resistance in the valves and piping. The curves show the performance with one, two and three electric pumps running. These performances are valid for liquids with density $\rho = 1.0 \text{ Kg/dm}^3$ and kinematic viscosity $\nu = 1 \text{ mm}^2/\text{sec}$.
The declared NPSH values are laboratory values; for practical use we recommend increasing these values by 0,5 m.

GS.../SV BOOSTER SETS SERIES OPERATING CHARACTERISTICS AT 50 Hz (SERVICE)

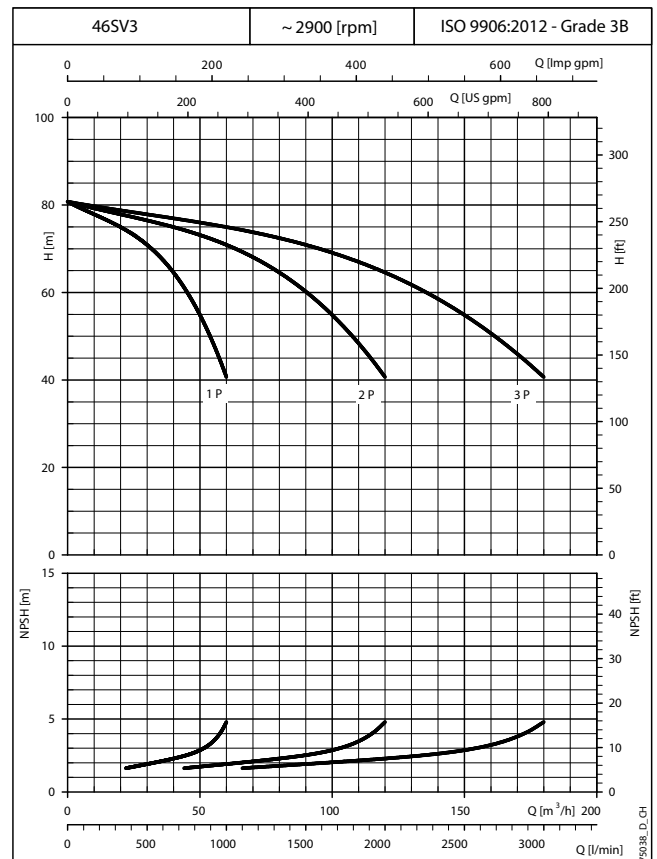
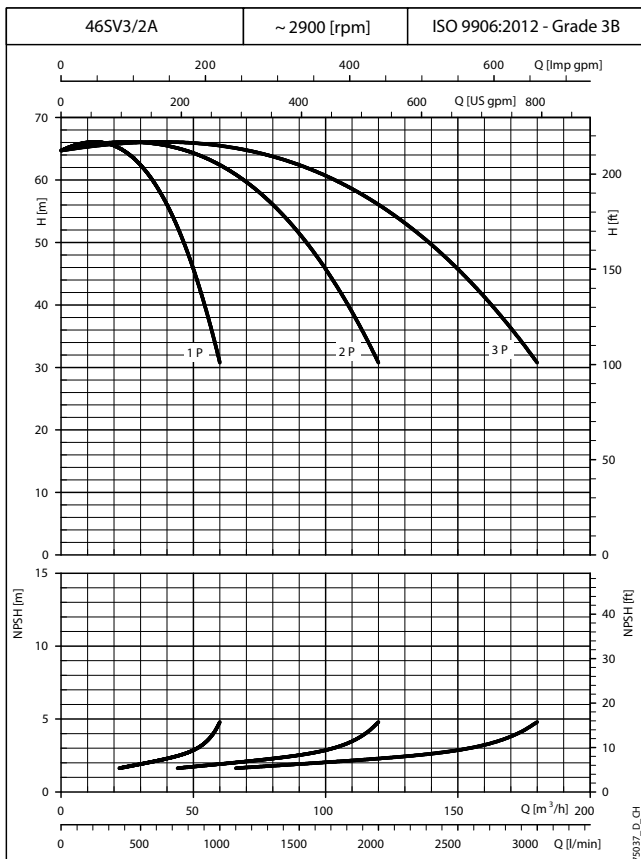
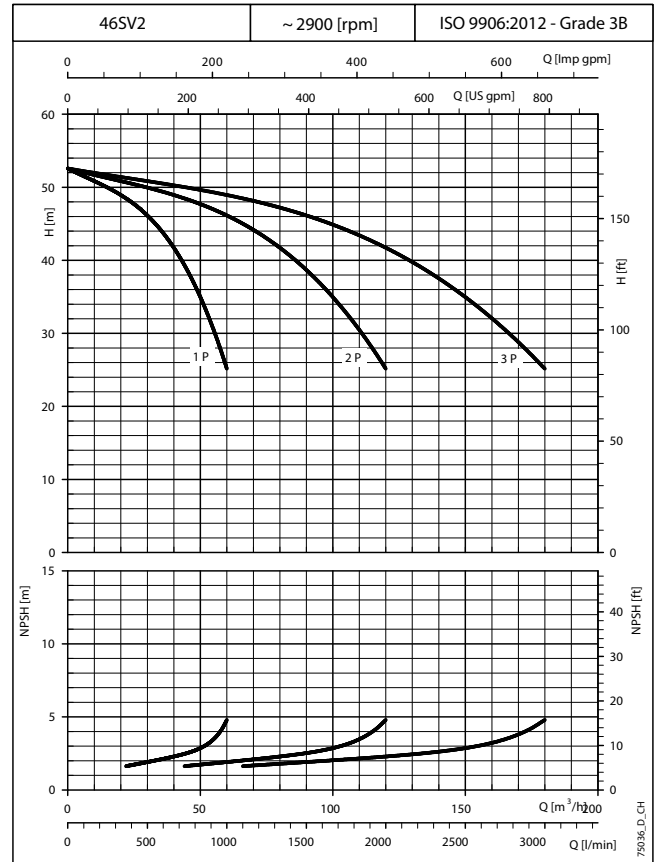
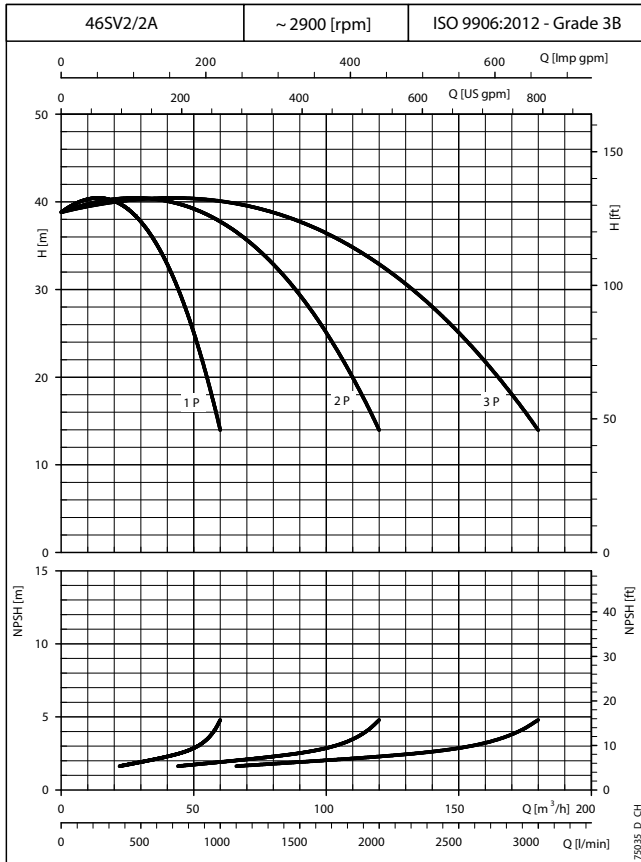

The performance curves do not take into account flow resistance in the valves and piping. The curves show the performance with one, two and three electric pumps running. These performances are valid for liquids with density $\rho = 1.0 \text{ Kg/dm}^3$ and kinematic viscosity $\nu = 1 \text{ mm}^2/\text{sec}$.
The declared NPSH values are laboratory values; for practical use we recommend increasing these values by 0,5 m.

GS.../SV BOOSTER SETS SERIES OPERATING CHARACTERISTICS AT 50 Hz (SERVICE)

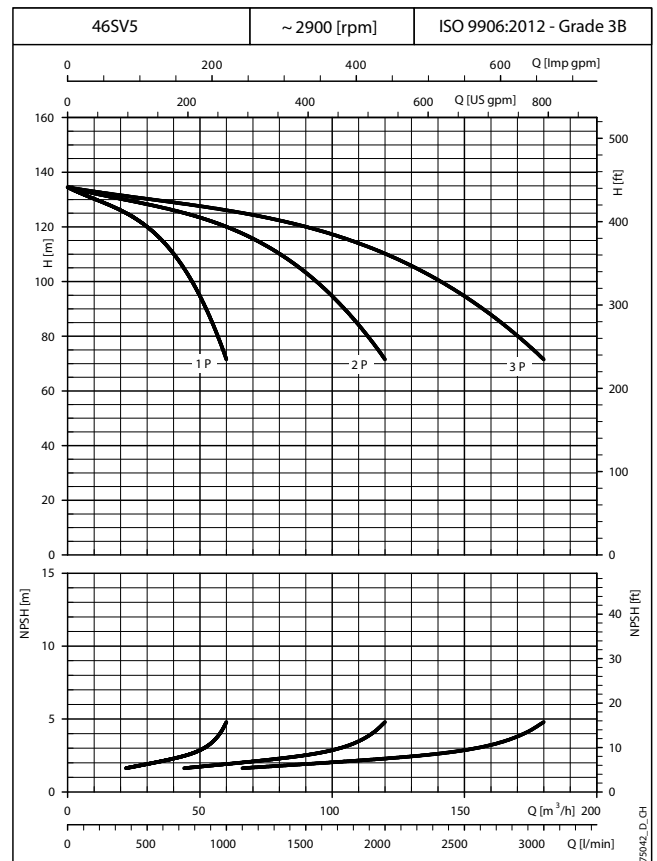
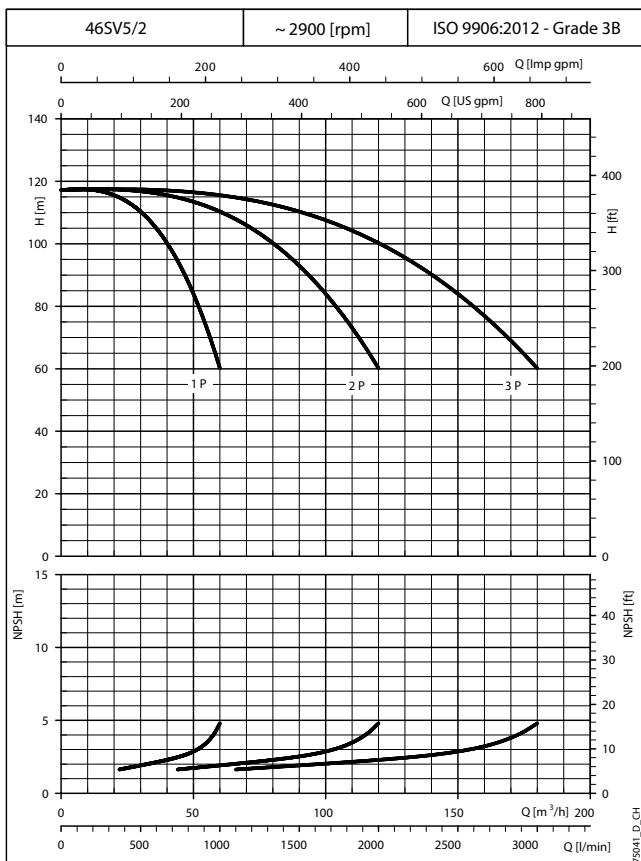
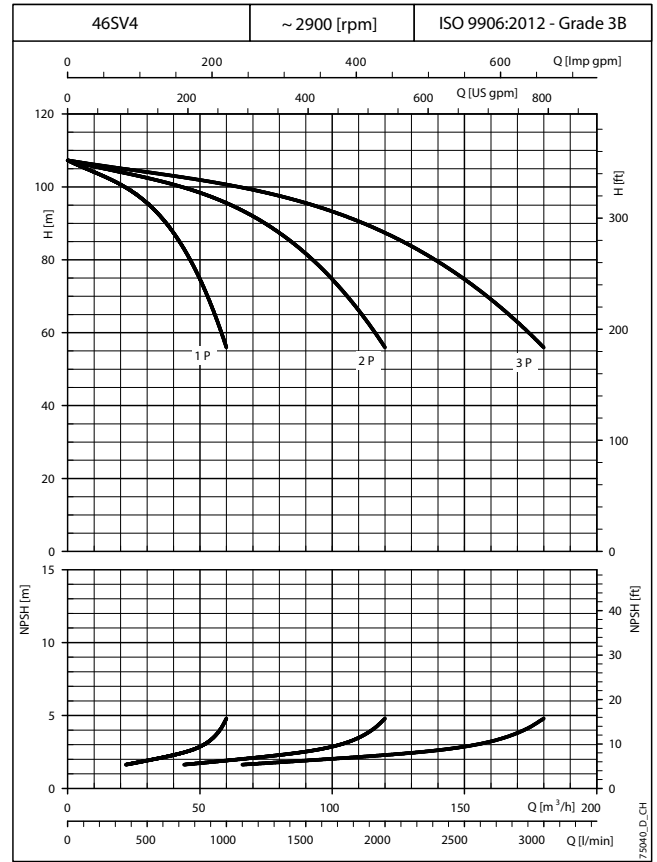
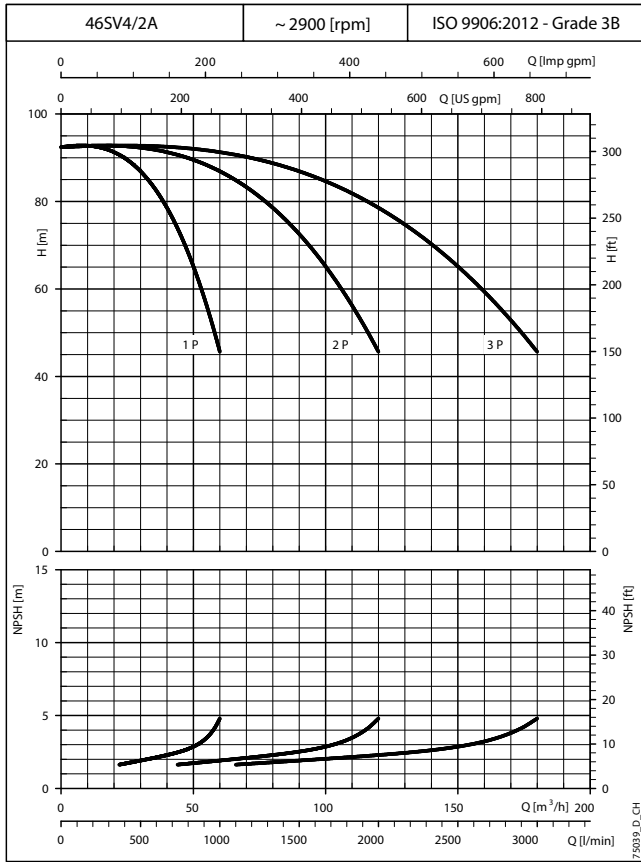

The performance curves do not take into account flow resistance in the valves and piping. The curves show the performance with one, two and three electric pumps running. These performances are valid for liquids with density $\rho = 1.0 \text{ Kg/dm}^3$ and kinematic viscosity $\nu = 1 \text{ mm}^2/\text{sec}$.
The declared NPSH values are laboratory values; for practical use we recommend increasing these values by 0,5 m.

GS.../SV BOOSTER SETS SERIES OPERATING CHARACTERISTICS AT 50 Hz (SERVICE)

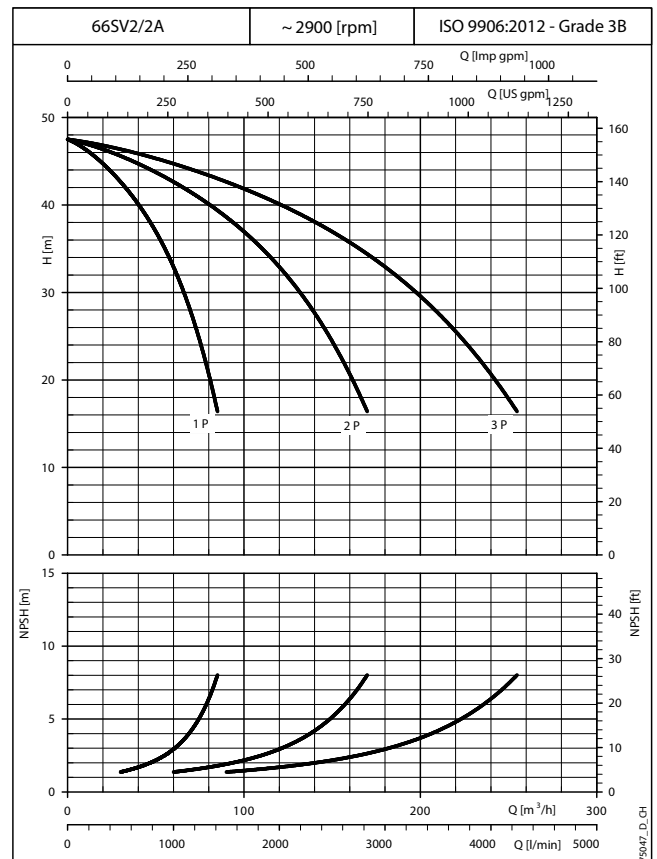
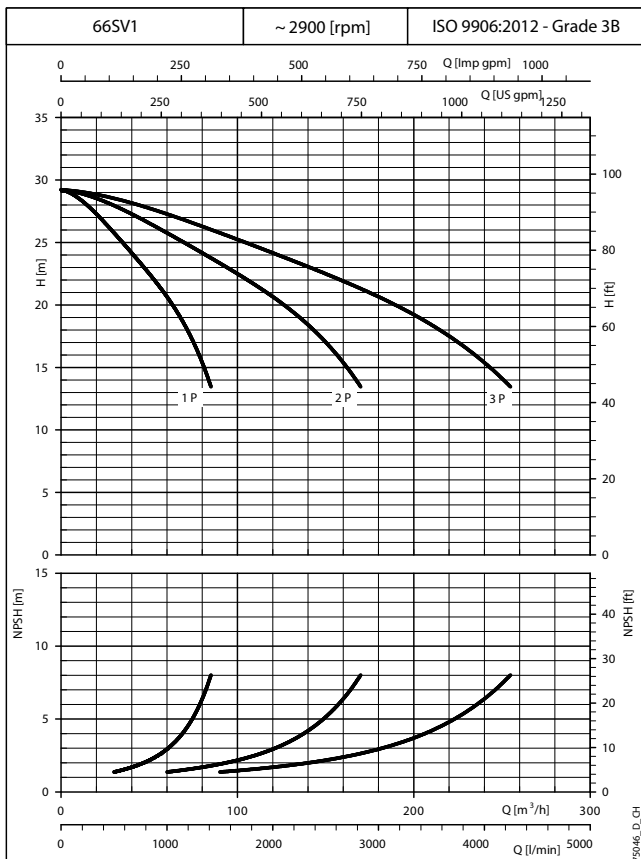
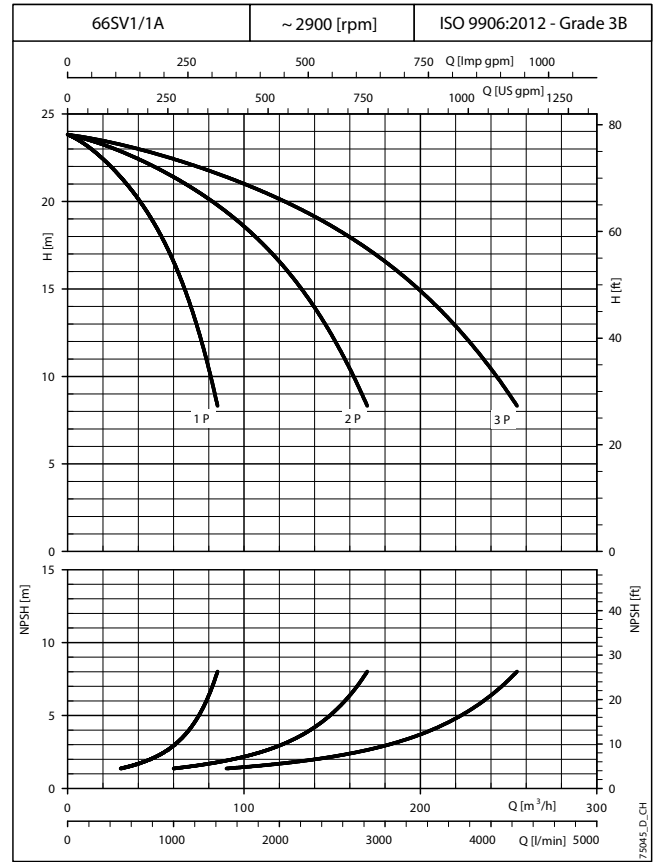
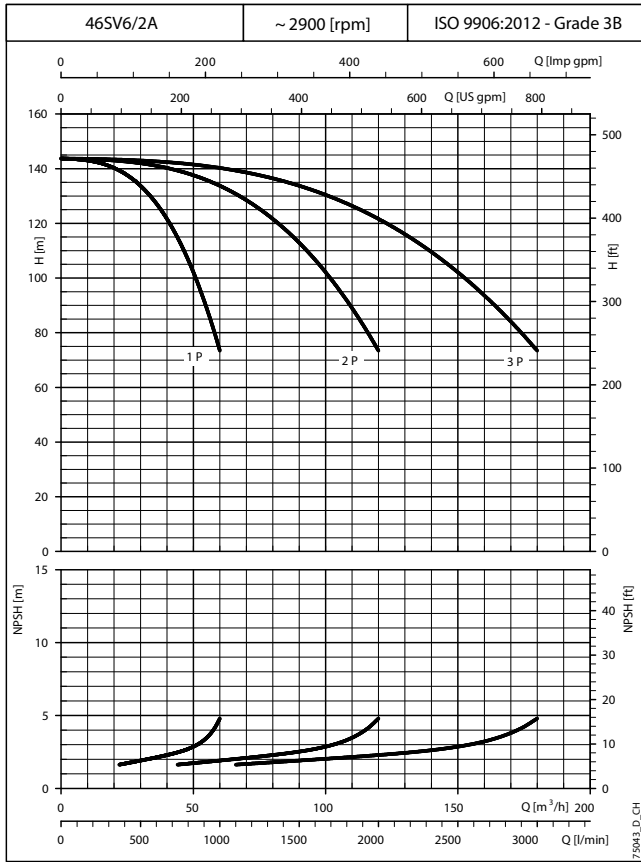

The performance curves do not take into account flow resistance in the valves and piping. The curves show the performance with one, two and three electric pumps running. These performances are valid for liquids with density $\rho = 1.0 \text{ Kg/dm}^3$ and kinematic viscosity $\nu = 1 \text{ mm}^2/\text{sec}$.
The declared NPSH values are laboratory values; for practical use we recommend increasing these values by 0,5 m.

GS.../SV BOOSTER SETS SERIES OPERATING CHARACTERISTICS AT 50 Hz (SERVICE)

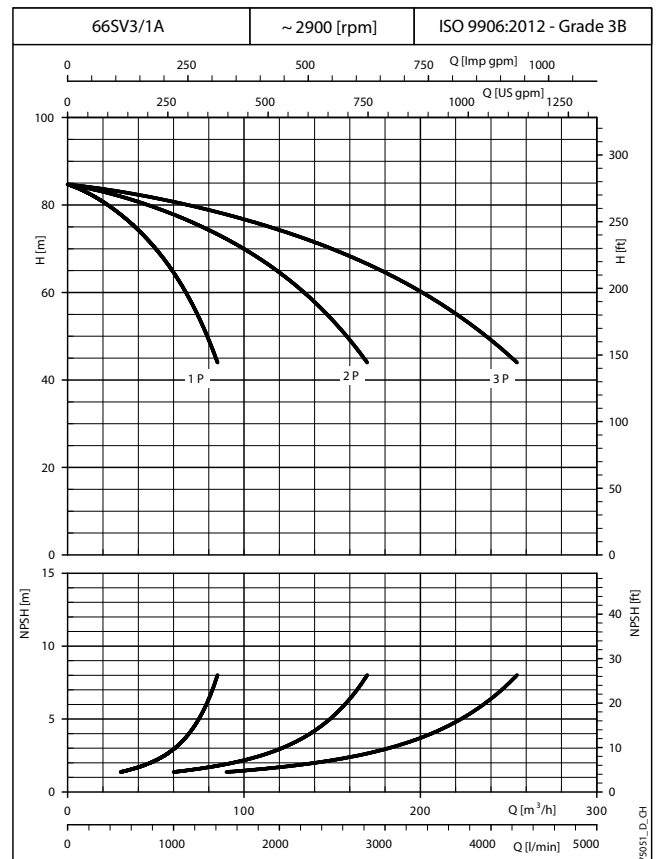
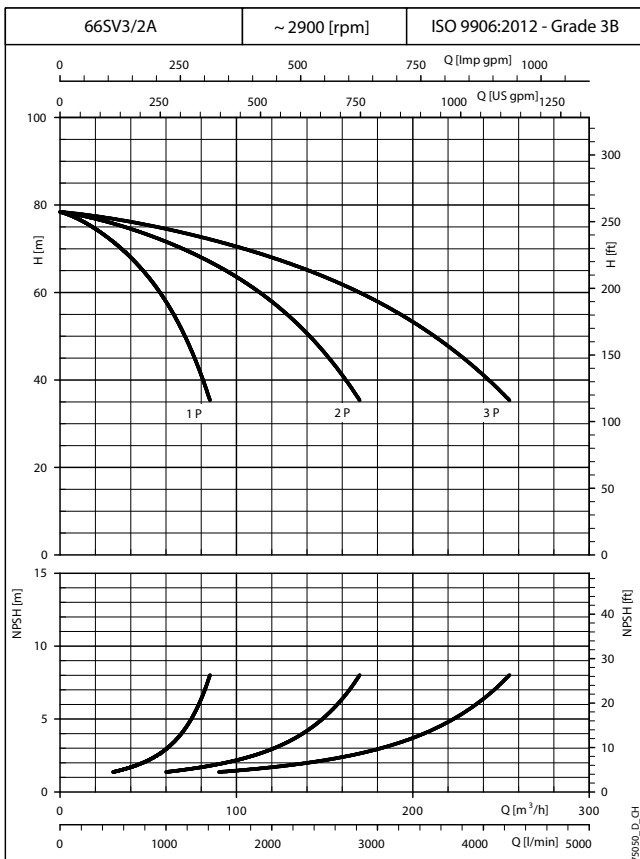
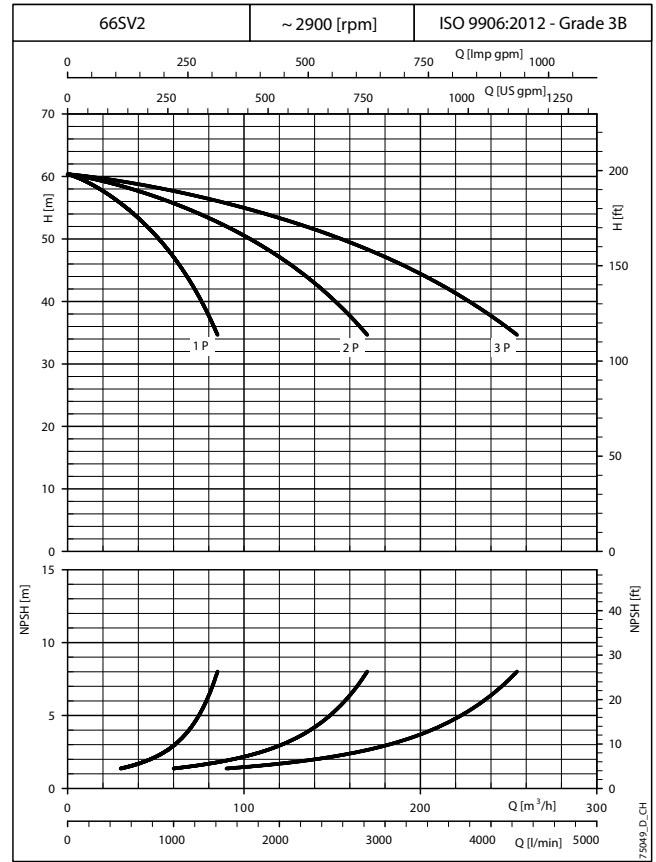
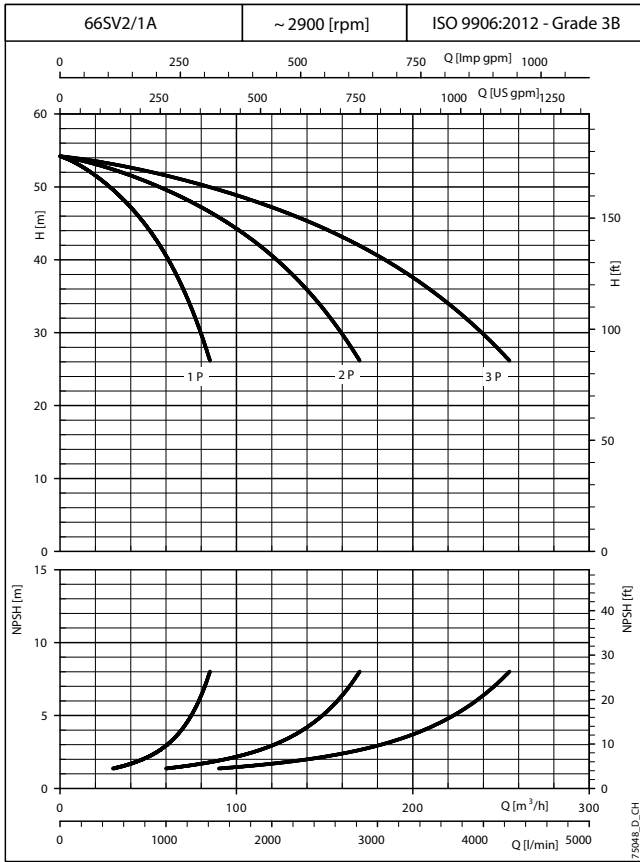

The performance curves do not take into account flow resistance in the valves and piping. The curves show the performance with one, two and three electric pumps running. These performances are valid for liquids with density $\rho = 1.0 \text{ Kg/dm}^3$ and kinematic viscosity $\nu = 1 \text{ mm}^2/\text{sec}$.
The declared NPSH values are laboratory values; for practical use we recommend increasing these values by 0,5 m.

GS.../SV BOOSTER SETS SERIES OPERATING CHARACTERISTICS AT 50 Hz (SERVICE)

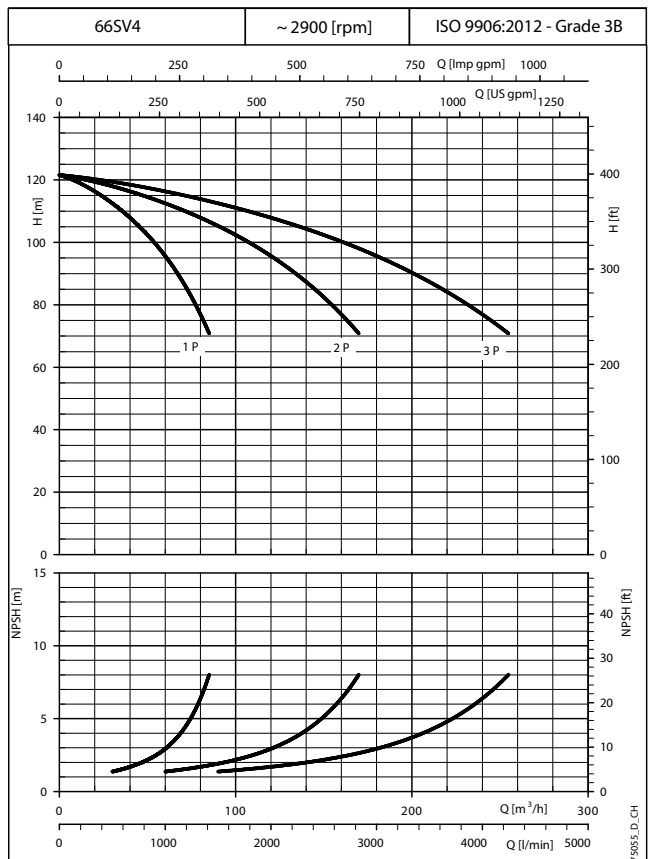
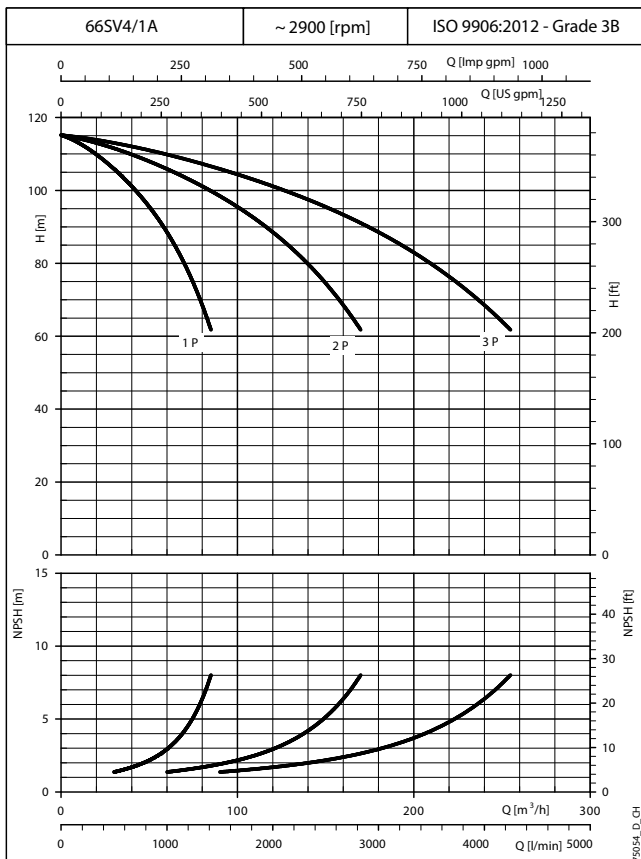
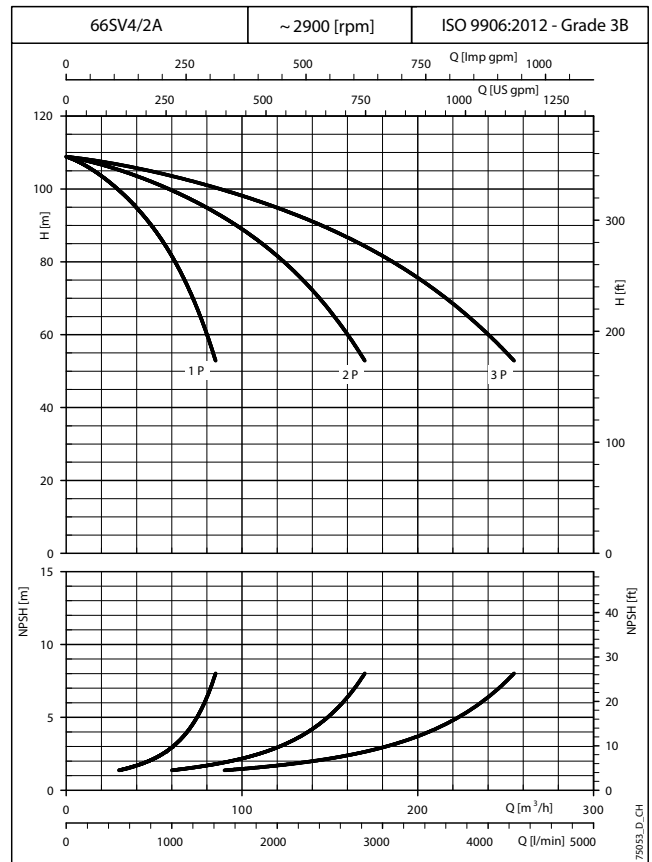
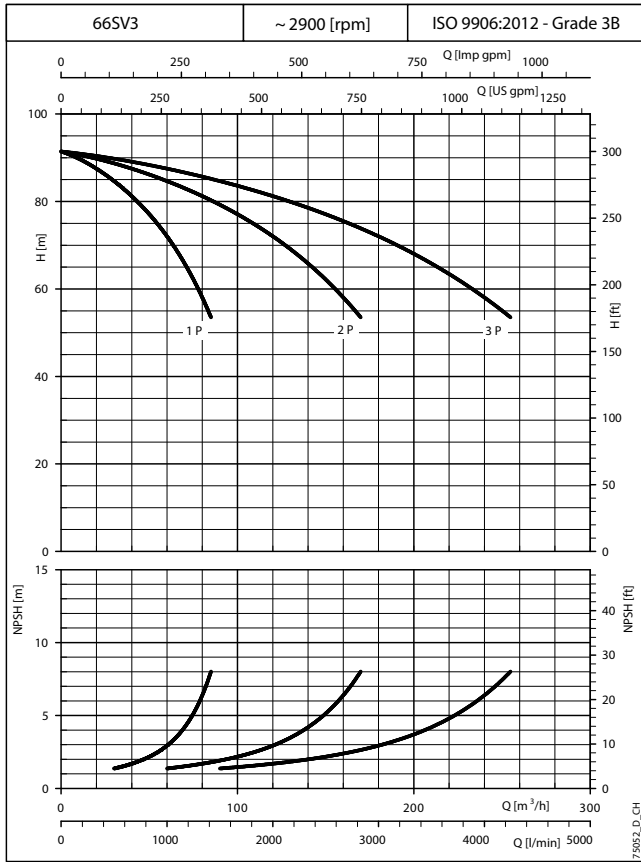

The performance curves do not take into account flow resistance in the valves and piping. The curves show the performance with one, two and three electric pumps running. These performances are valid for liquids with density $\rho = 1.0 \text{ Kg/dm}^3$ and kinematic viscosity $\nu = 1 \text{ mm}^2/\text{sec}$.
The declared NPSH values are laboratory values; for practical use we recommend increasing these values by 0,5 m.

GS.../SV BOOSTER SETS SERIES OPERATING CHARACTERISTICS AT 50 Hz (SERVICE)

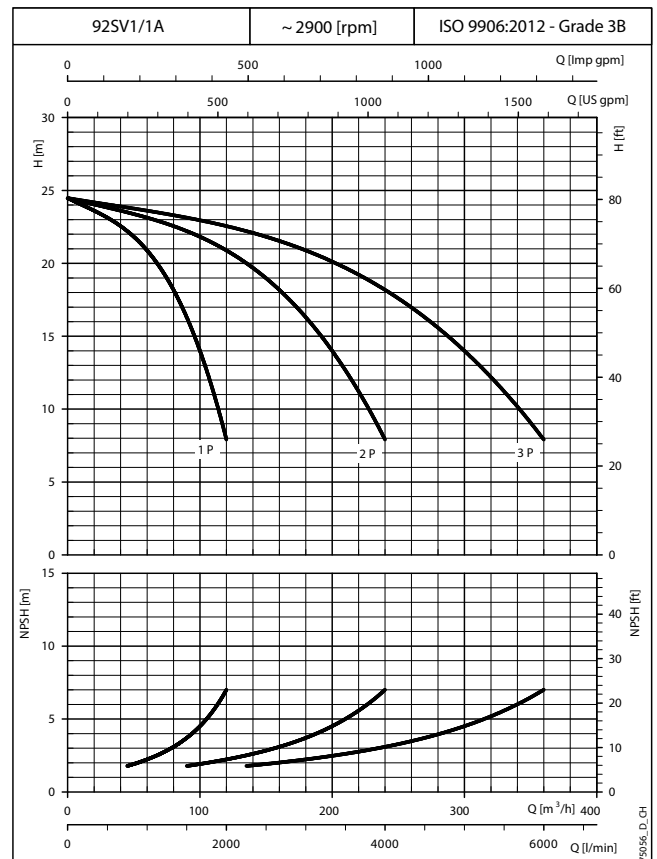
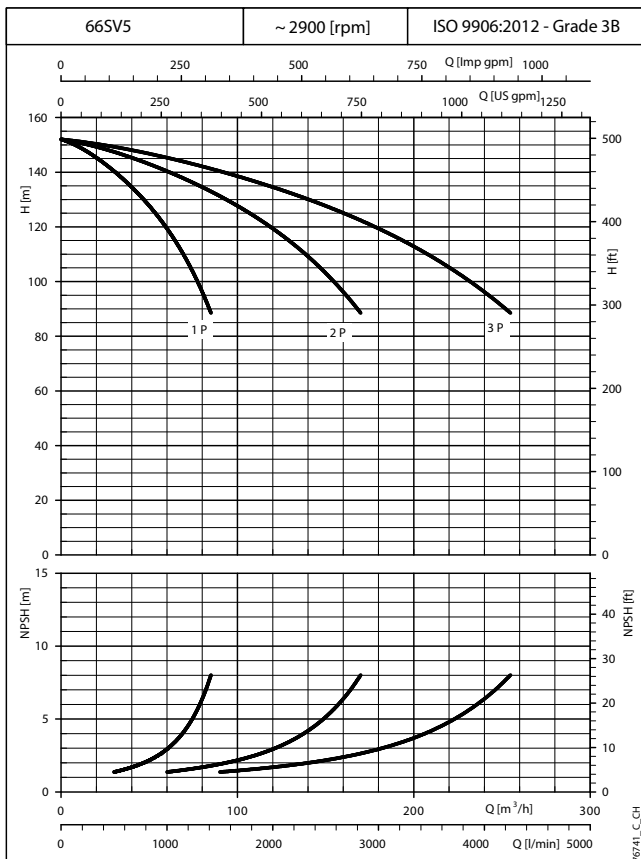
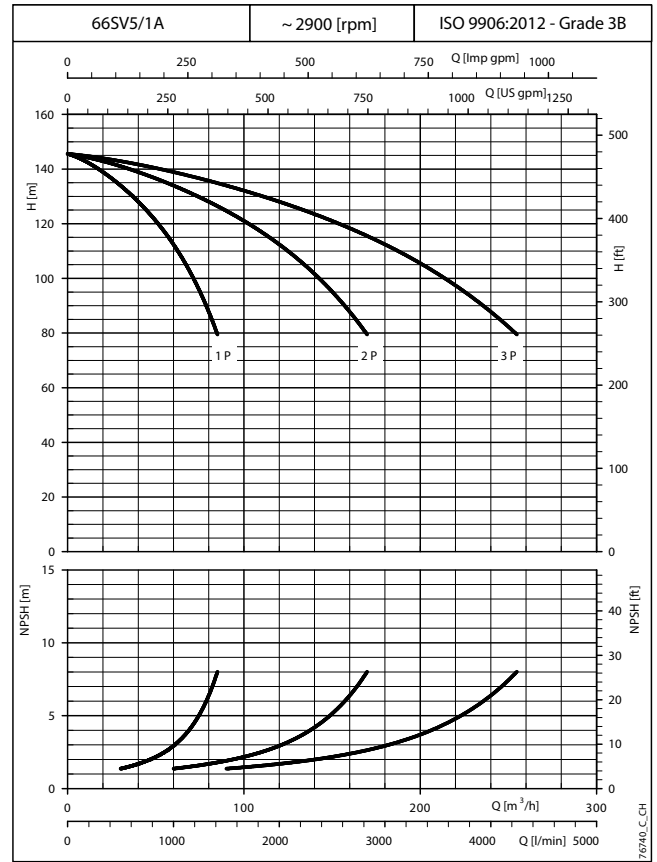
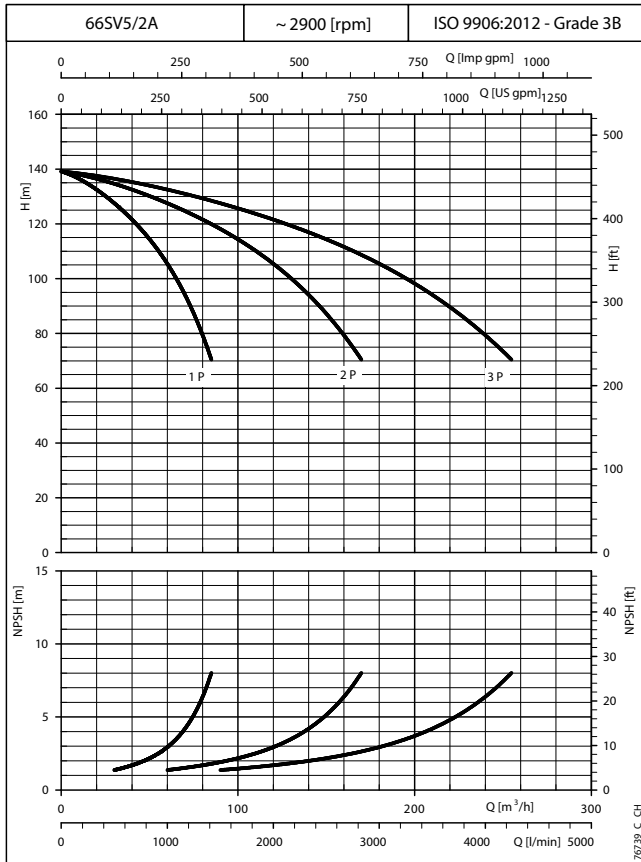

The performance curves do not take into account flow resistance in the valves and piping. The curves show the performance with one, two and three electric pumps running. These performances are valid for liquids with density $\rho = 1.0 \text{ Kg/dm}^3$ and kinematic viscosity $\nu = 1 \text{ mm}^2/\text{sec}$.
The declared NPSH values are laboratory values; for practical use we recommend increasing these values by 0,5 m.

GS.../SV BOOSTER SETS SERIES OPERATING CHARACTERISTICS AT 50 Hz (SERVICE)

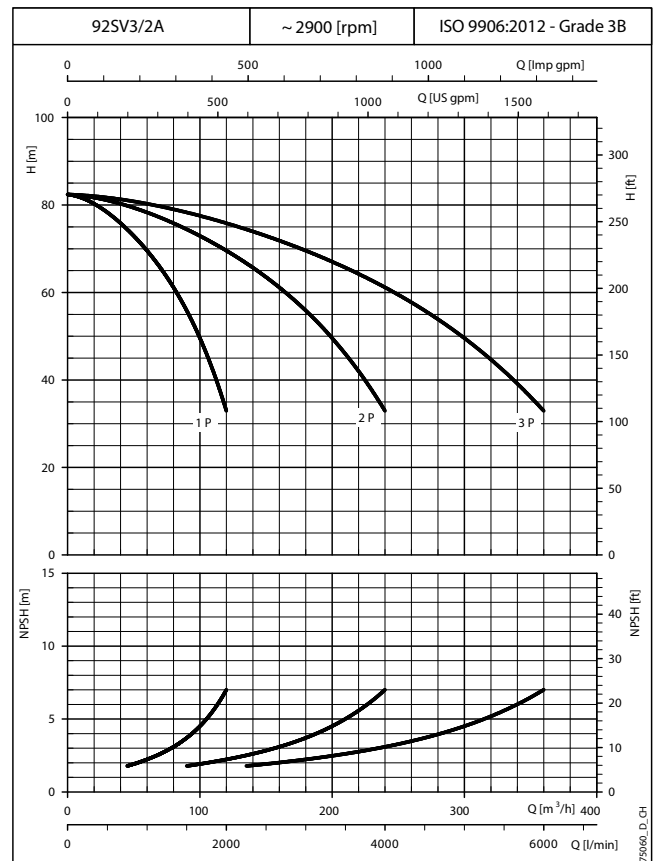
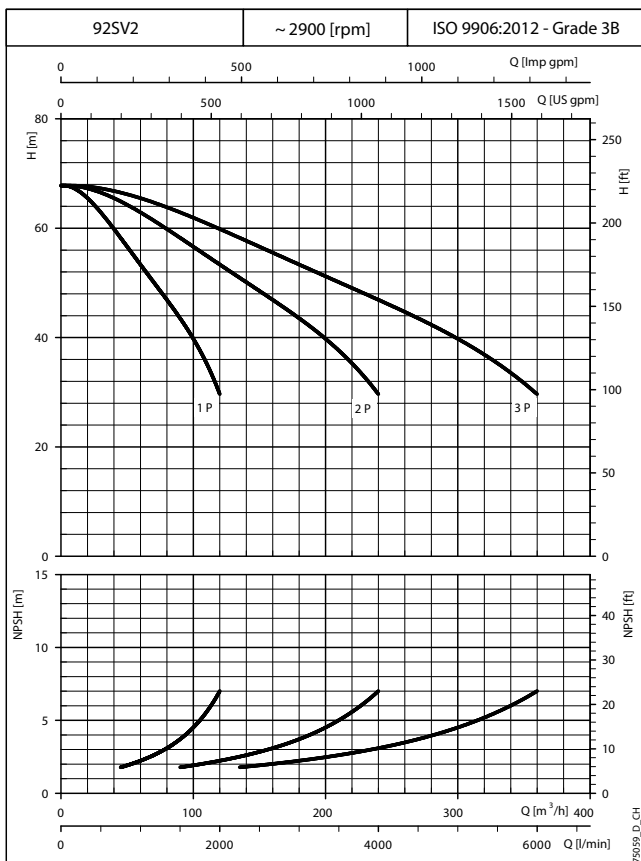
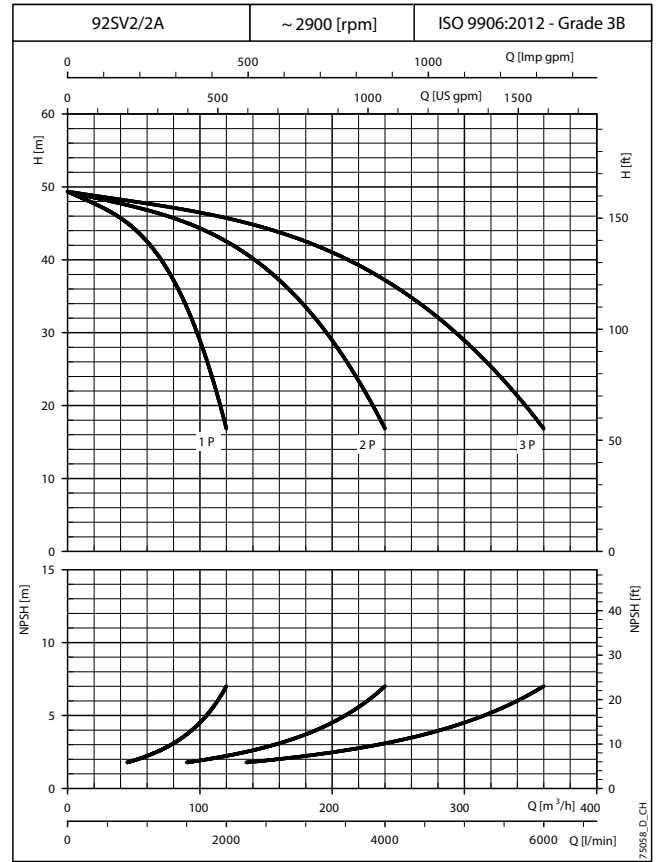
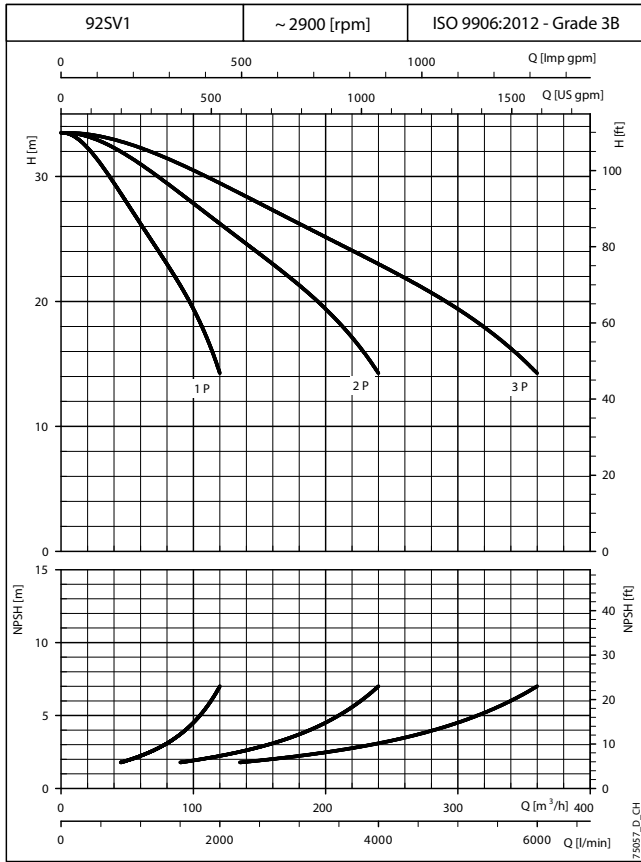

The performance curves do not take into account flow resistance in the valves and piping. The curves show the performance with one, two and three electric pumps running. These performances are valid for liquids with density $\rho = 1.0 \text{ Kg/dm}^3$ and kinematic viscosity $\nu = 1 \text{ mm}^2/\text{sec}$.
The declared NPSH values are laboratory values; for practical use we recommend increasing these values by 0,5 m.

GS.../SV BOOSTER SETS SERIES OPERATING CHARACTERISTICS AT 50 Hz (SERVICE)

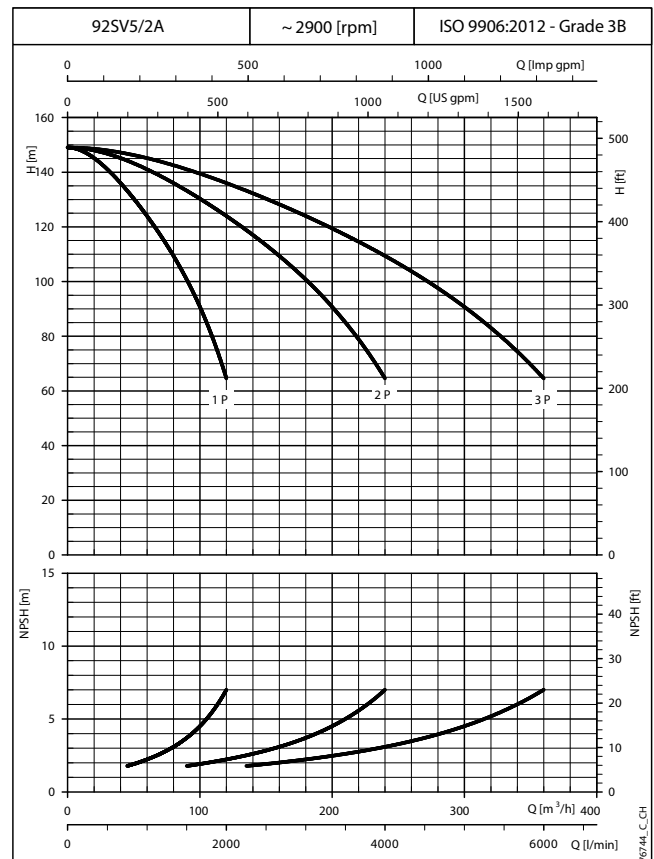
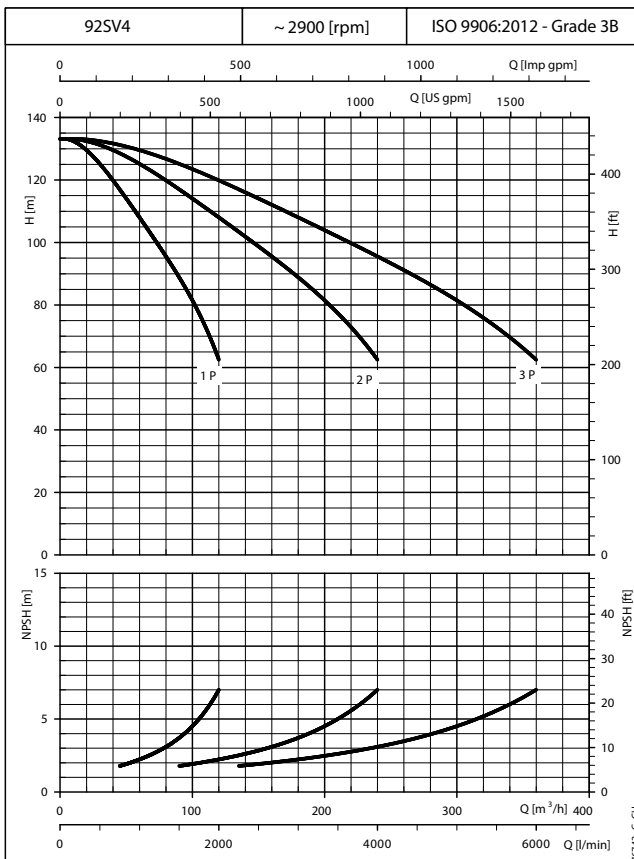
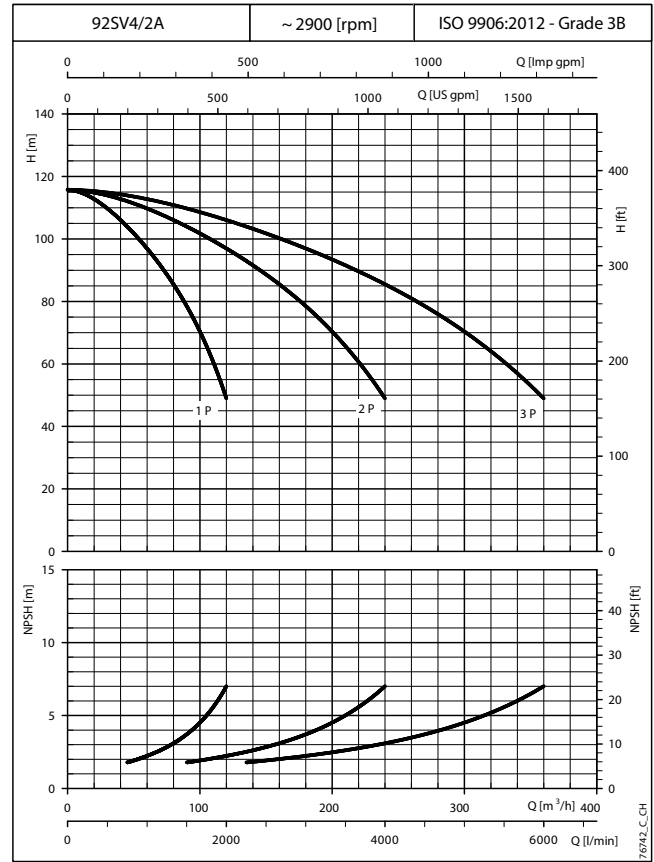
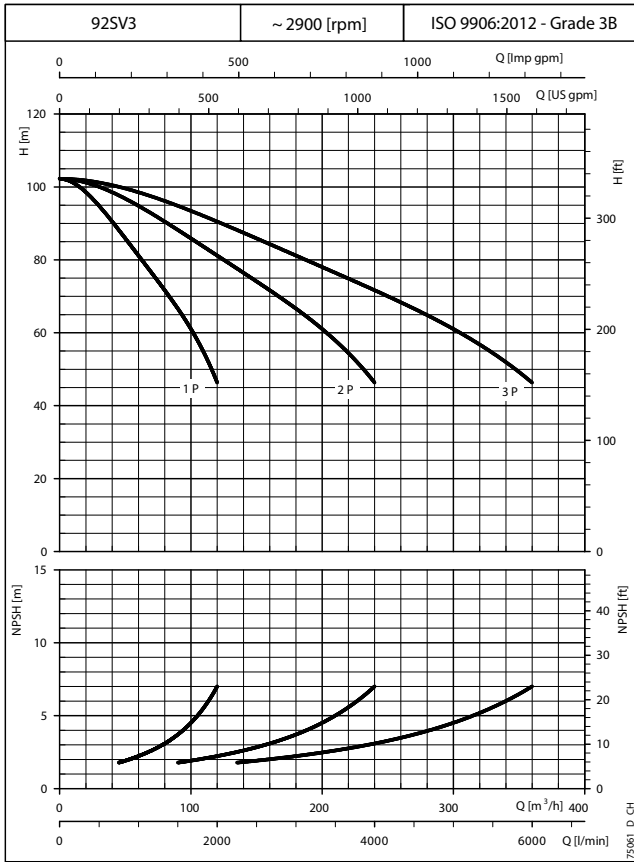

The performance curves do not take into account flow resistance in the valves and piping. The curves show the performance with one, two and three electric pumps running. These performances are valid for liquids with density $\rho = 1.0 \text{ Kg/dm}^3$ and kinematic viscosity $\nu = 1 \text{ mm}^2/\text{sec}$.
The declared NPSH values are laboratory values; for practical use we recommend increasing these values by 0,5 m.

GS.../SV BOOSTER SETS SERIES OPERATING CHARACTERISTICS AT 50 Hz (SERVICE)

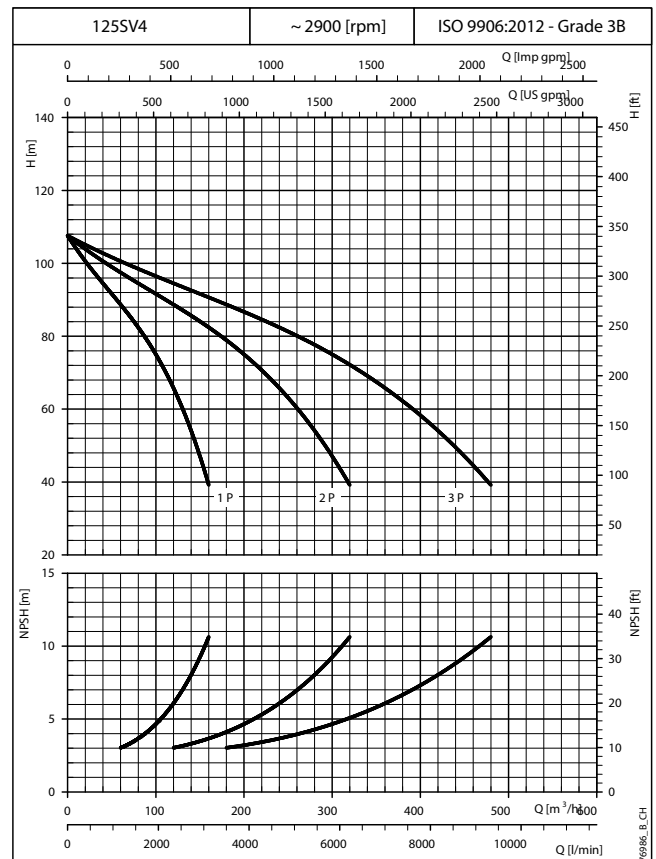
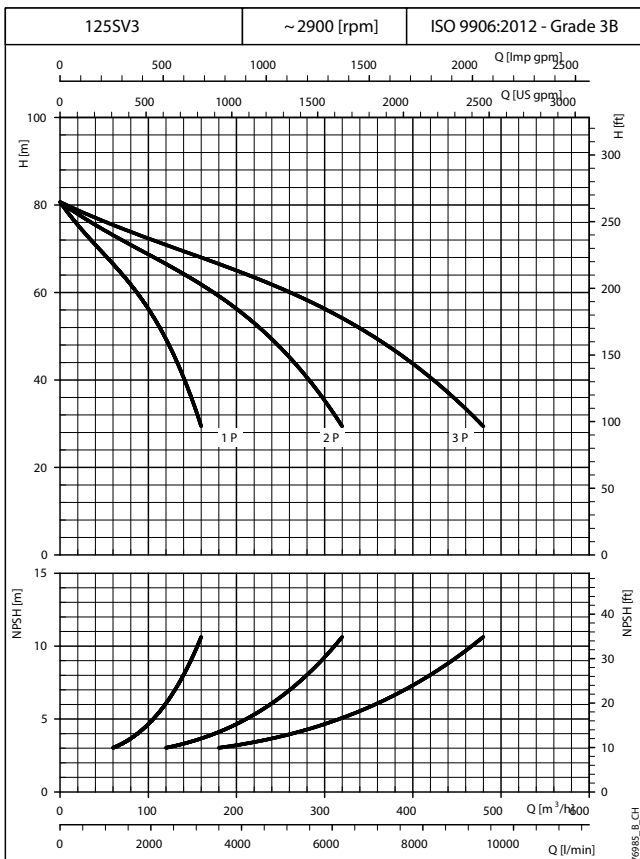
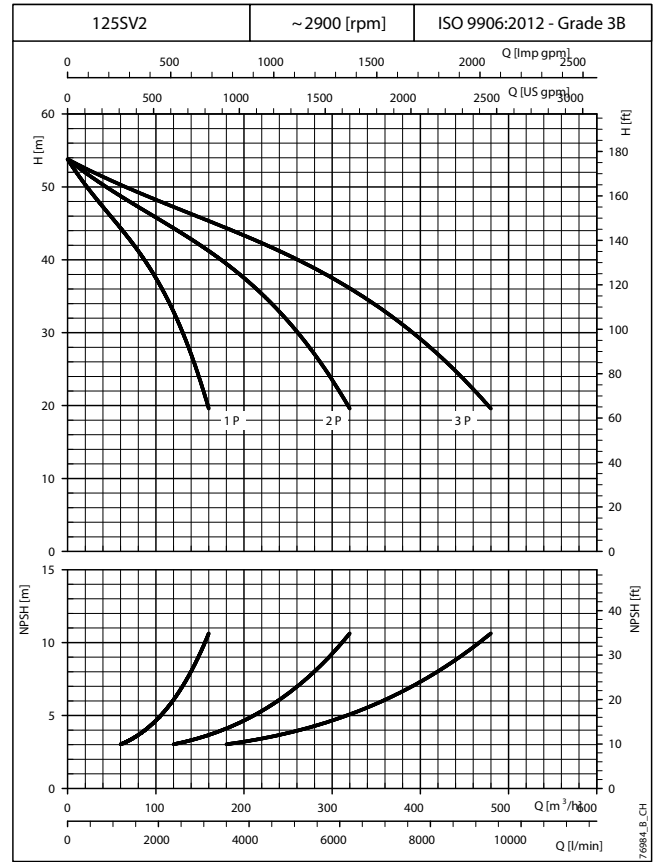
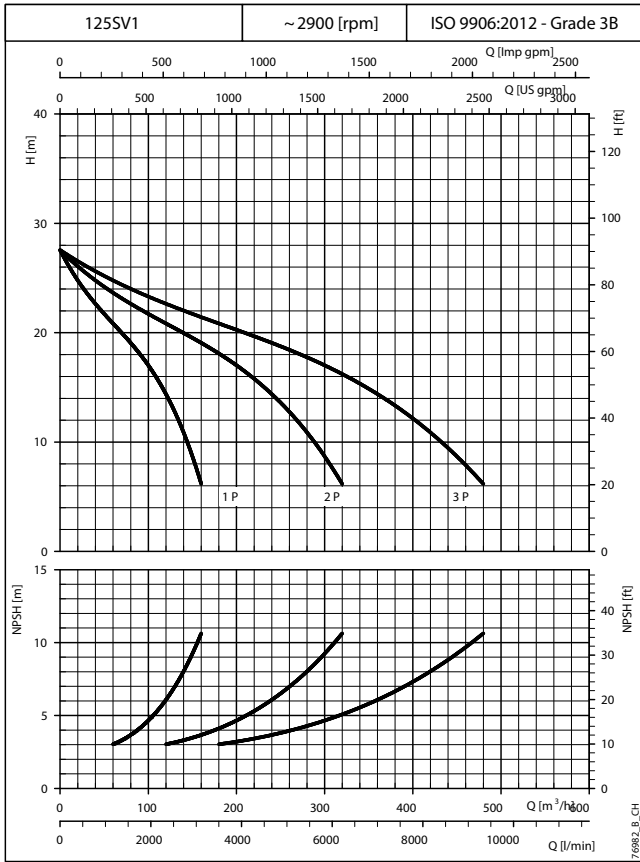

The performance curves do not take into account flow resistance in the valves and piping. The curves show the performance with one, two and three electric pumps running. These performances are valid for liquids with density $\rho = 1.0 \text{ Kg/dm}^3$ and kinematic viscosity $\nu = 1 \text{ mm}^2/\text{sec}$.
The declared NPSH values are laboratory values; for practical use we recommend increasing these values by 0,5 m.

**GS.../SV BOOSTER SETS SERIES
OPERATING CHARACTERISTICS AT 50 Hz (SERVICE)**

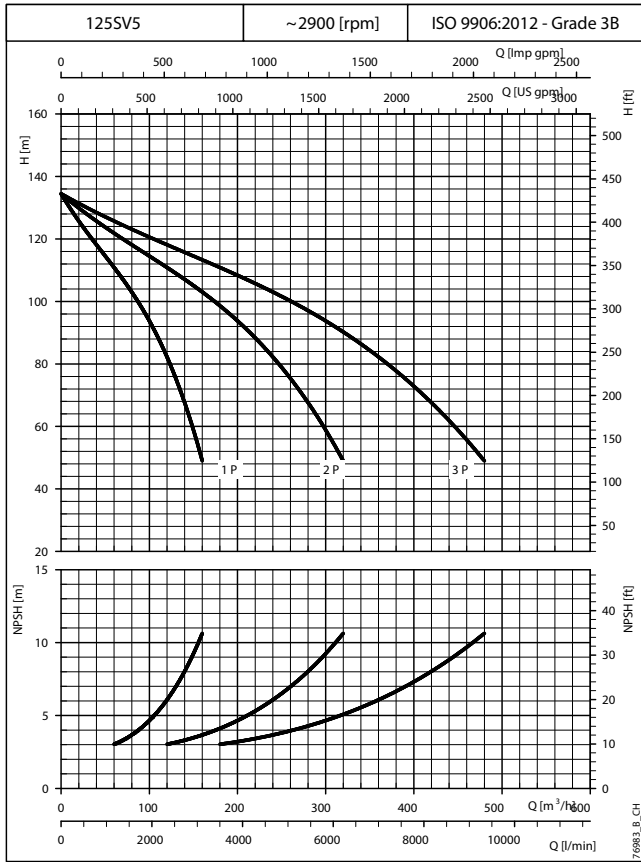

The performance curves do not take into account flow resistance in the valves and piping. The curves show the performance with one, two and three electric pumps running. These performances are valid for liquids with density $\rho = 1.0 \text{ Kg/dm}^3$ and kinematic viscosity $\nu = 1 \text{ mm}^2/\text{sec}$. The declared NPSH values are laboratory values; for practical use we recommend increasing these values by 0,5 m.

GS.../SV BOOSTER SETS SERIES H_c PRESSURE DROP CURVE

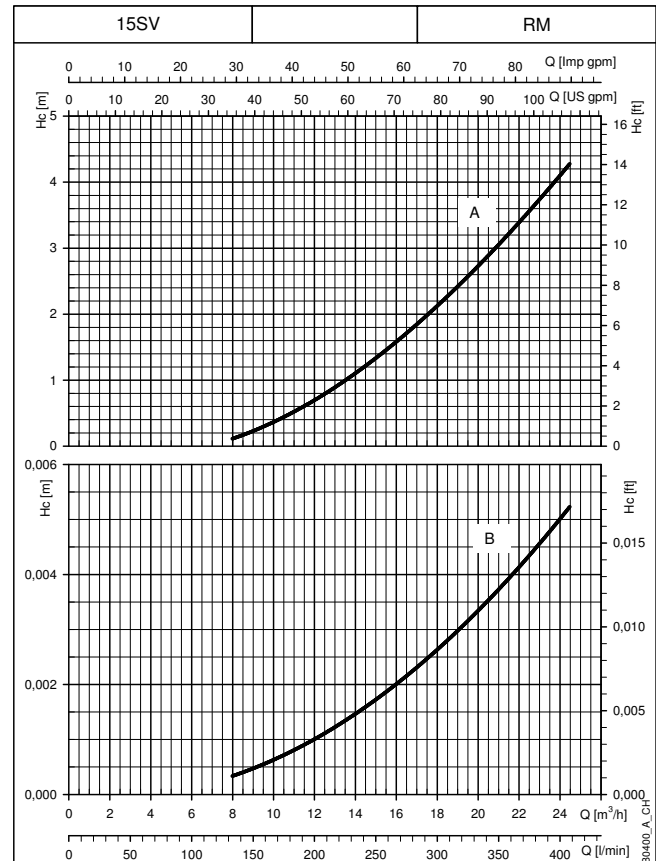
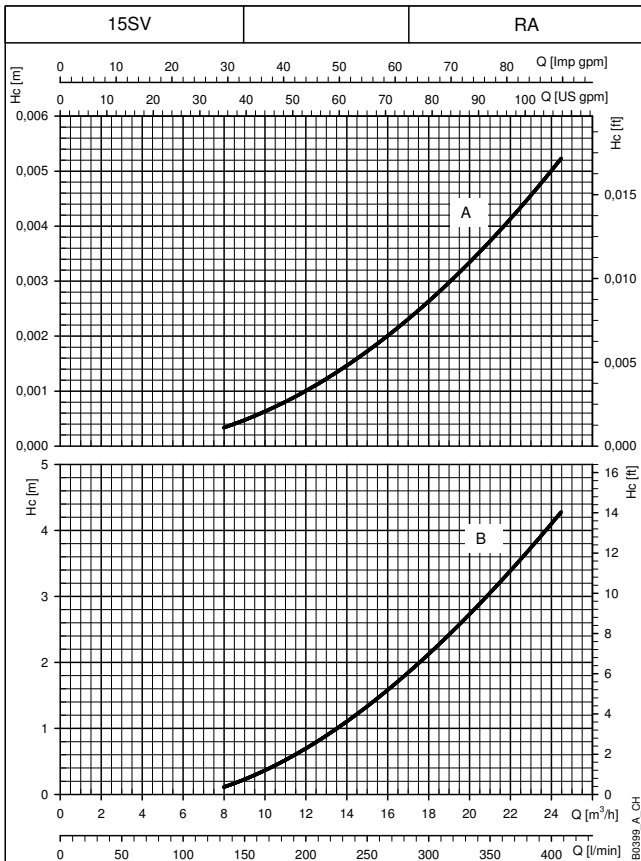
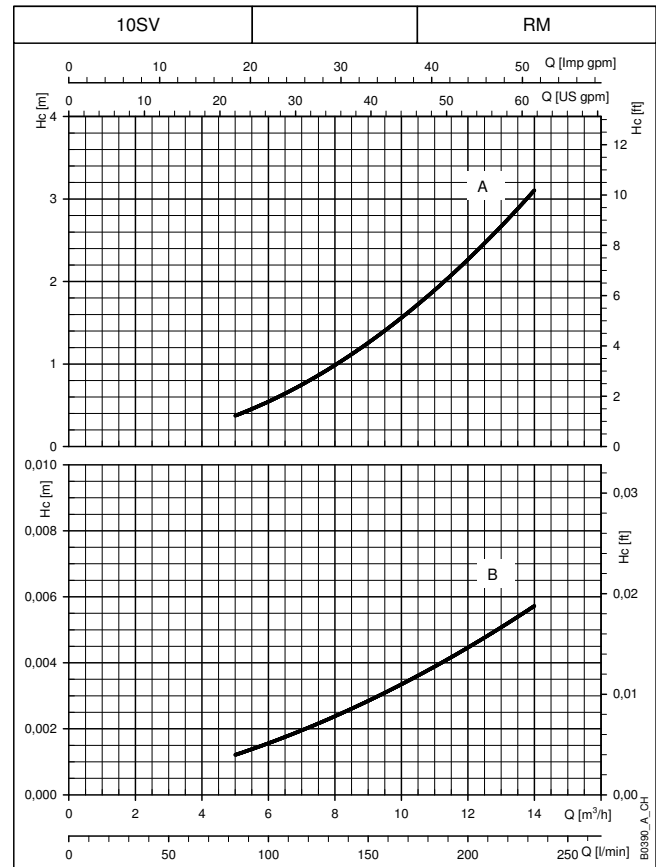
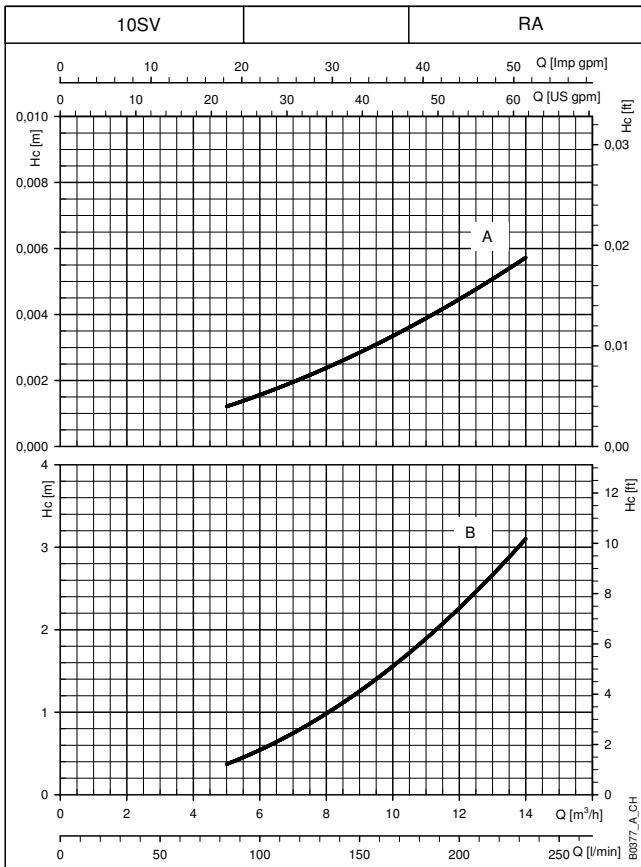

The declared curves are valid for liquids with density $\rho = 1 \text{ Kg/dm}^3$ and kinematic viscosity $\nu = 1 \text{ mm}^2/\text{sec}$.
H_c (A): Pressure drop curve on delivery side of the pump. H_c (B): Pressure drop curve on suction side of the pump.
RA: check valve on suction side. RM: check valve on delivery side.
The pressure drops do not consider the distributed pressure drops on the manifold.

GS.../SV BOOSTER SETS SERIES H_c PRESSURE DROP CURVE

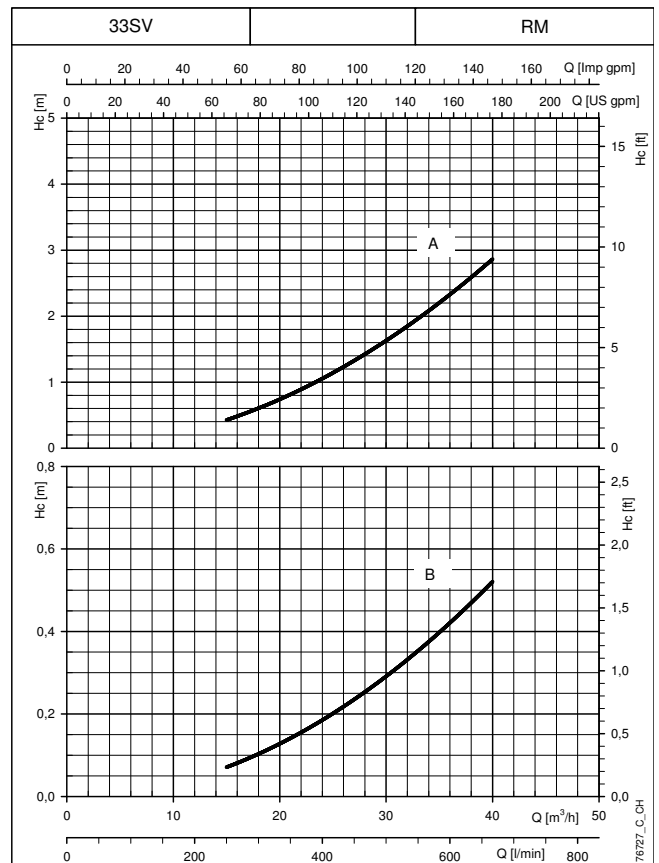
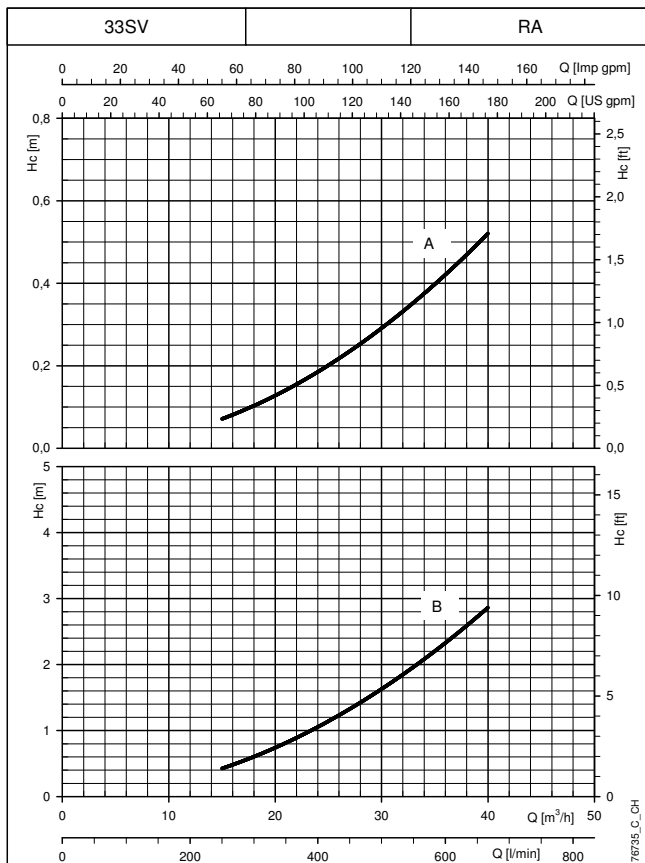
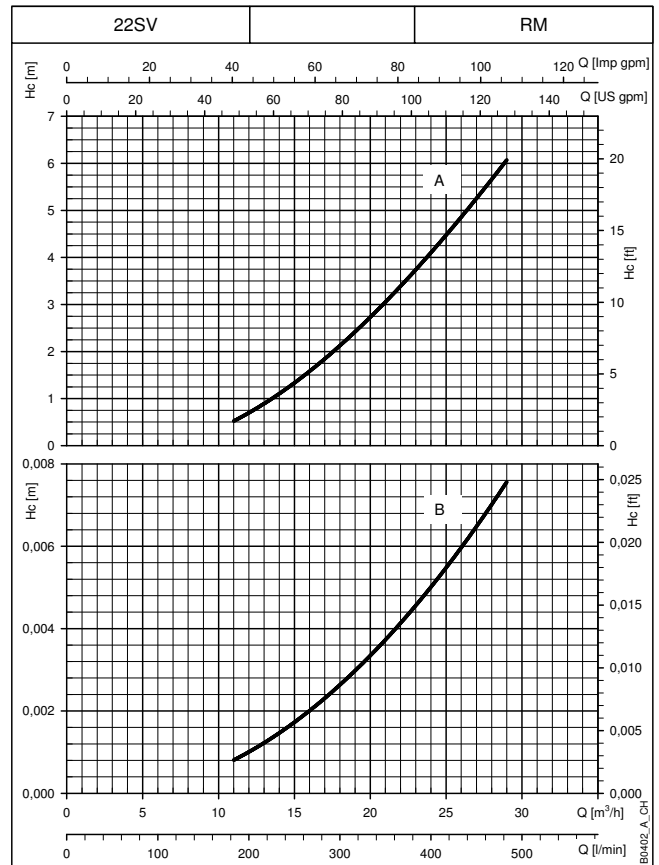
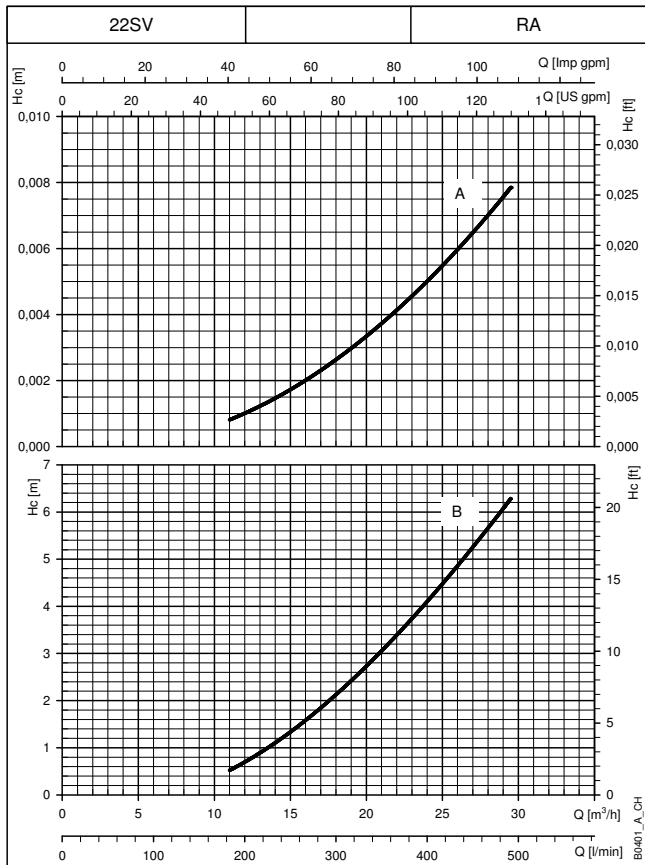

The declared curves are valid for liquids with density $\rho = 1 \text{ Kg/dm}^3$ and kinematic viscosity $\nu = 1 \text{ mm}^2/\text{sec}$.
 H_c (A): Pressure drop curve on delivery side of the pump. H_c (B): Pressure drop curve on suction side of the pump.
 RA: check valve on suction side. RM: check valve on delivery side.
 The pressure drops do not consider the distributed pressure drops on the manifold.

GS.../SV BOOSTER SETS SERIES H_c PRESSURE DROP CURVE

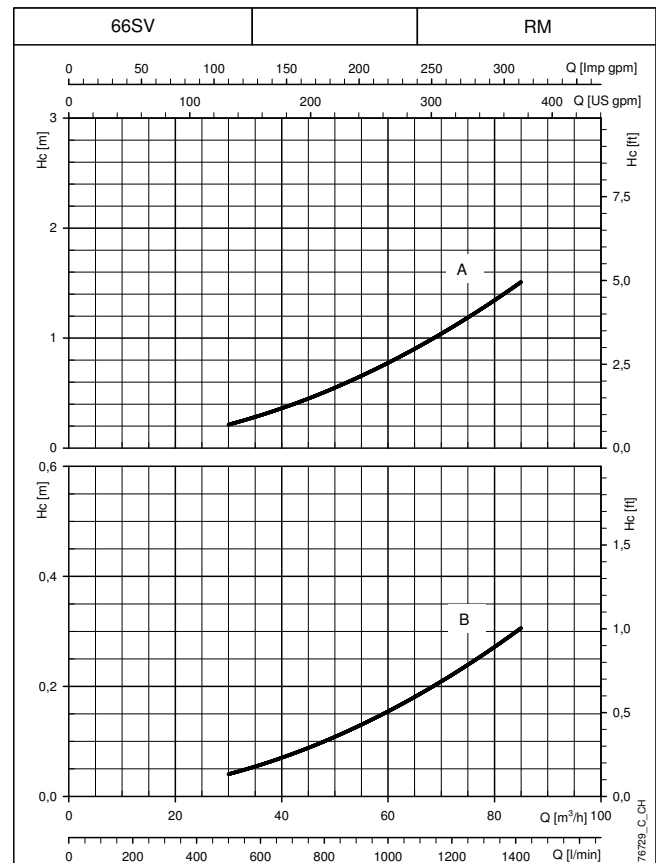
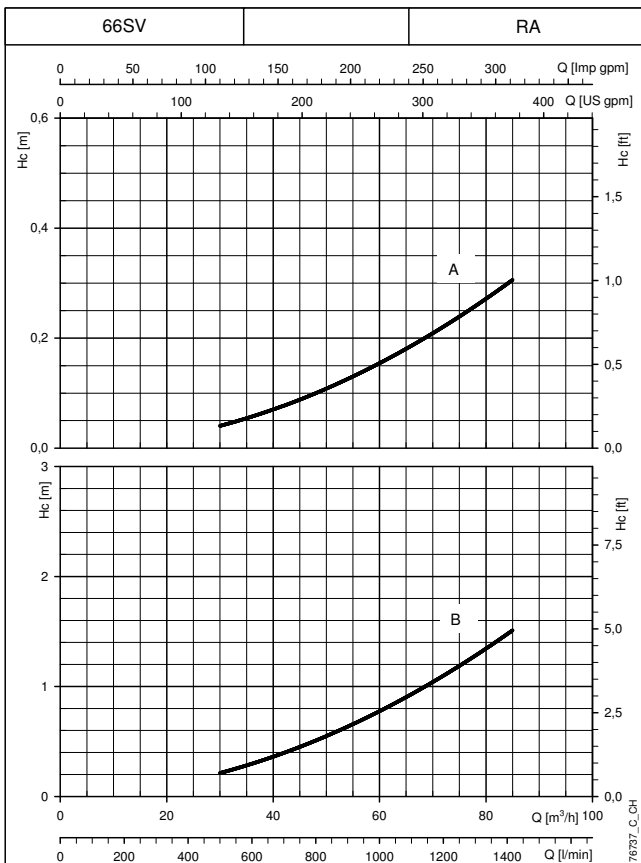
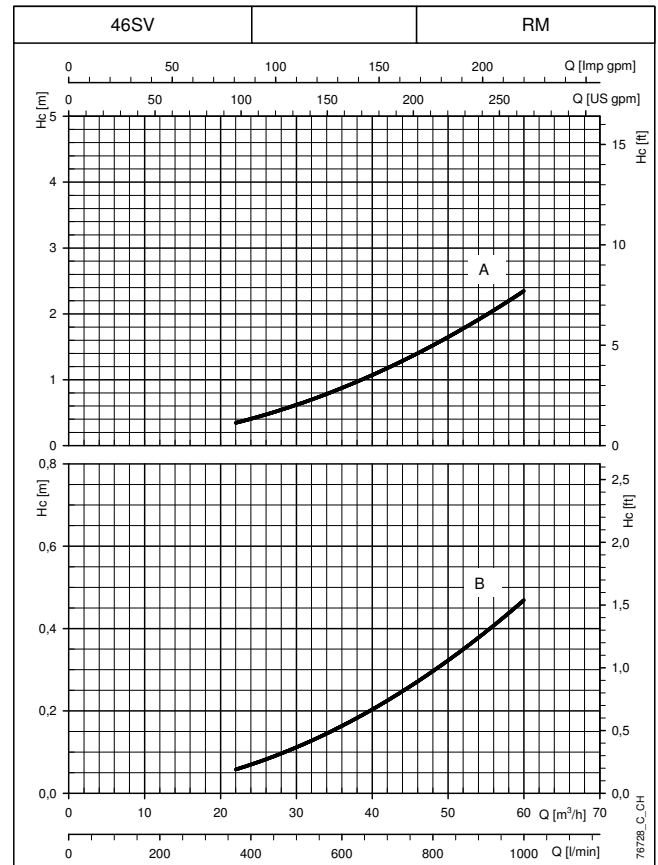
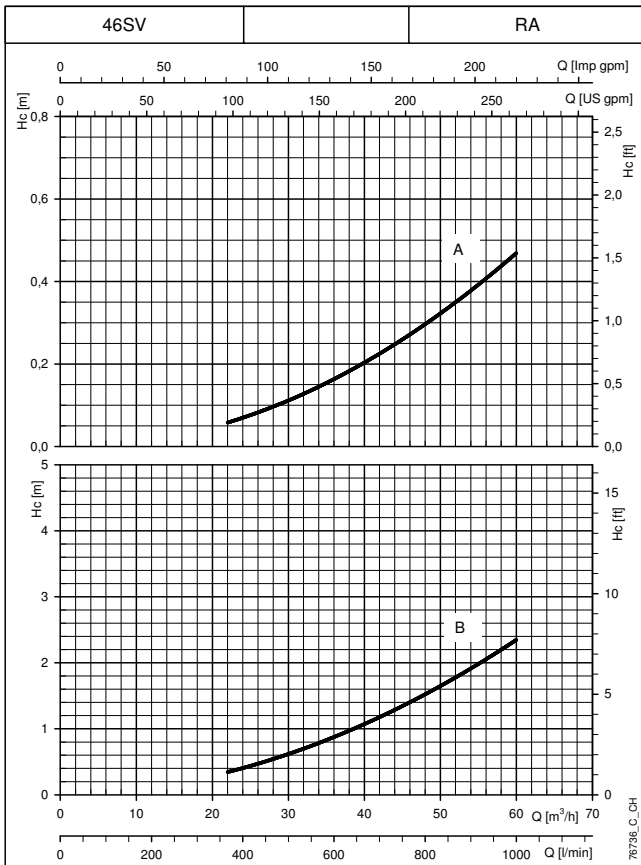

The declared curves are valid for liquids with density $\rho = 1 \text{ Kg/dm}^3$ and kinematic viscosity $\nu = 1 \text{ mm}^2/\text{sec}$.
 H_c (A): Pressure drop curve on delivery side of the pump. H_c (B): Pressure drop curve on suction side of the pump.
 RA: check valve on suction side. RM: check valve on delivery side.
 The pressure drops do not consider the distributed pressure drops on the manifold.

GS.../SV BOOSTER SETS SERIES H_c PRESSURE DROP CURVE

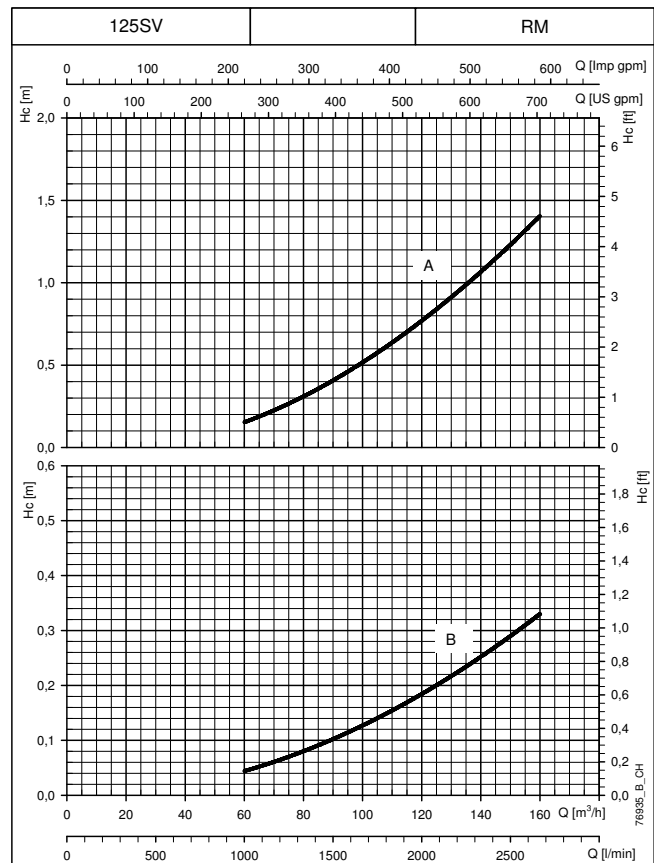
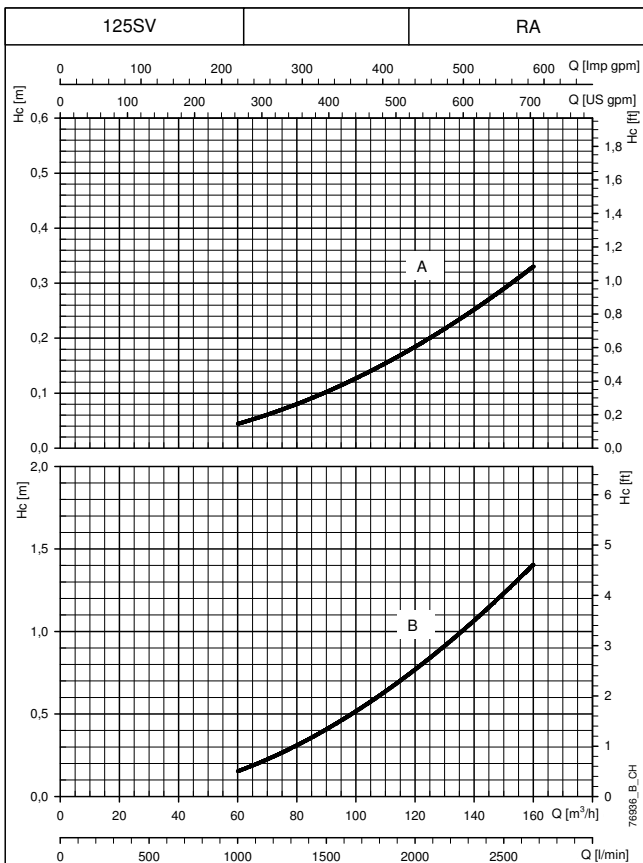
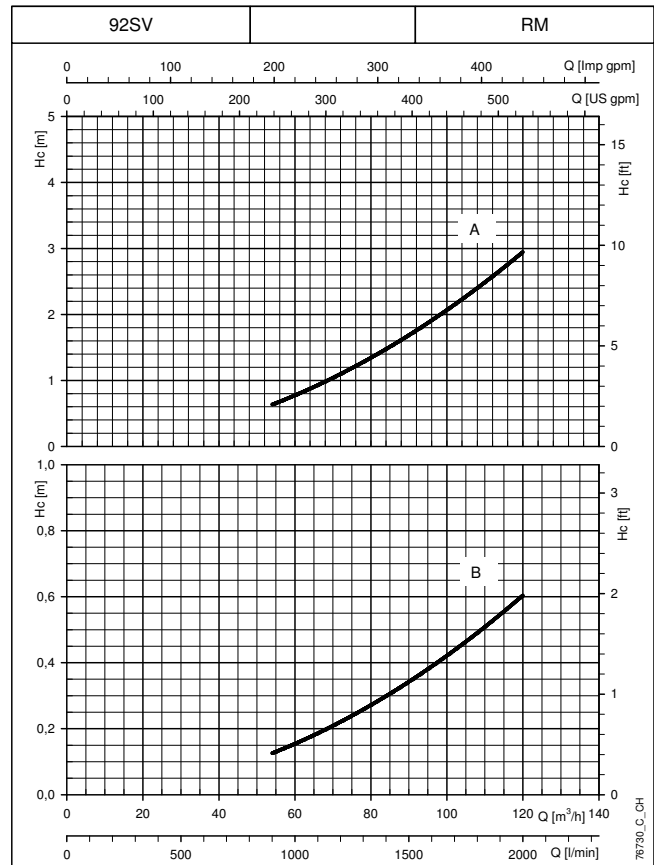
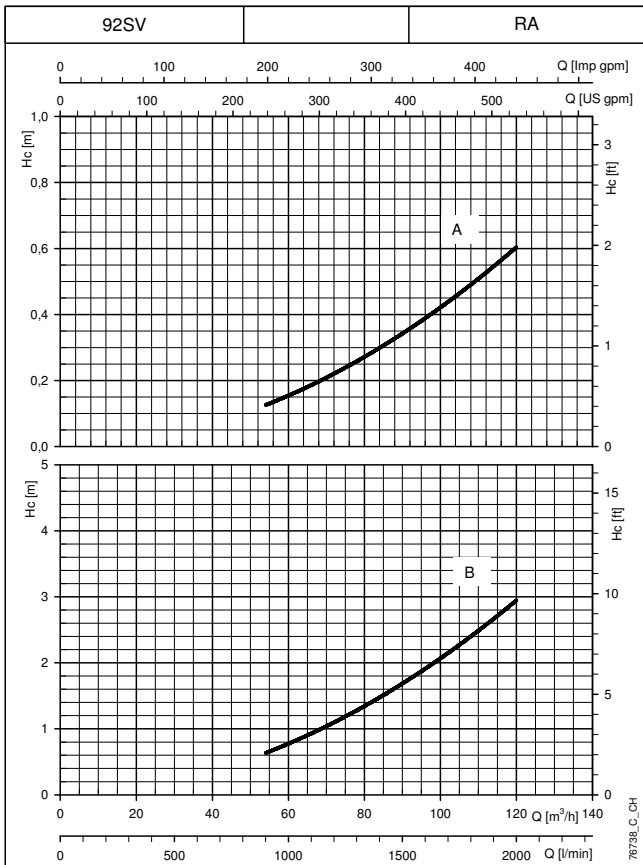

The declared curves are valid for liquids with density $\rho = 1 \text{ Kg/dm}^3$ and kinematic viscosity $\nu = 1 \text{ mm}^2/\text{sec}$.
 H_c (A): Pressure drop curve on delivery side of the pump. H_c (B): Pressure drop curve on suction side of the pump.
 RA: check valve on suction side. RM: check valve on delivery side.
 The pressure drops do not consider the distributed pressure drops on the manifold.

ACCESSORIES

DIAPHRAGM EXPANSION VESSELS

Booster sets have delivery manifolds with attachments for the installation of 8 or 24 litre diaphragm expansion vessels (hydrotube).

The caps for sealing any unused attachments are supplied with the set.

Any large size vessels can be connected to the unused end of the delivery manifold. For proper sizing of the vessel, please refer to the technical appendix.

Kits featuring the following accessories are **available on request**:

- expansion vessel.
- on-off valve.
- instructions sheet.
- packing.

DIAPHRAGM EXPANSION VESSELS KITS

Volume Litres	PN bar	DIMENSIONS (mm)			Materials		
		ø A	B	Valve	Diaphragm	Vessel	Valve
8	8	205	390	1" FF	EPDM	Painted steel	Nickel-plated brass
24	8	270	555	1" FF	EPDM	Painted steel	Nickel-plated brass
24	10	270	555	1" FF	EPDM	Painted steel	Nickel-plated brass
24	16	270	555	1" FF	EPDM	Painted steel	Nickel-plated brass
24	10	270	575	1" FF	Butyl	Stainless steel	AISI 316 stainless steel
20	25	270	555	1" FF	EPDM	Painted steel	Nickel-plated brass

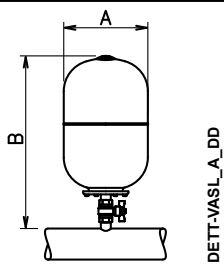

Gcom-vmb-en_c_td

FLANGE KIT

Manifolds up to 3" in diameter are usually supplied with threaded couplings and caps on unused end.

For these manifolds, stainless steel AISI 304 or 316 flanges for connection to the system are available on request.

THREADED FLANGES

KIT TYPE	DN	ø C	DIMENSIONS (mm)				HOLES		
			ø A	B	ø D	H	ø F	N°	PN
2"	50	Rp 2	125	16	165	24	18	4	25
2" 1/2	65	Rp 2 1/2	145	16	185	23	18	4	16
3"	80	Rp 3	160	17	200	27	18	8	16

Gcom-ctf-tonde-f-en_a_td

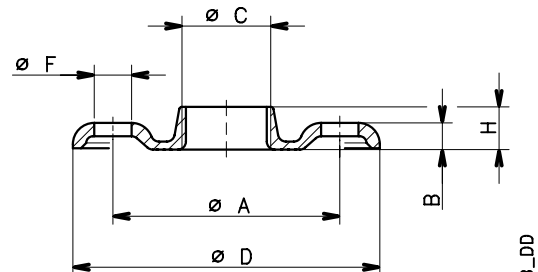

WELD-ON FLANGES

KIT TYPE	DN	ø C	DIMENSIONS (mm)				HOLES		
			ø A	B	ø D	ø F	N°	PN	
2"	50	61,5	125	20	165	18	4	16	
2"1/2	65	77,5	145	20	185	18	4	16	
3"	80	90,5	160	20	200	18	8	16	
4"	100	116	180	22	220	18	8	16	
5"	125	141,5	210	22	250	18	8	16	
6"	150	170,5	240	24	285	22	8	16	
8"	200	221,5	295	26	340	22	12	16	
10"	250	276,5	355	29	405	26	12	16	
12"	300	327,5	410	32	460	26	12	16	

Gcom-ctf-tonde-s-en_d_td

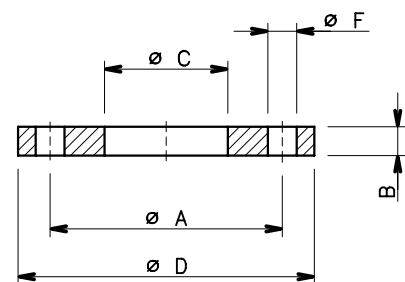

ANTI-VIBRATION JOINT KIT

Anti-vibration joints, or compensation joints, can be used to absorb deformations, expansions, pipe noise and reduce water hammering. They can also withstand a high level of vacuum, which enables the absorption of negative expansions due to depression.

Due to its elasticity, the material can deform or expand as necessary, making installation easier, simpler and quicker, even when the piping is not aligned.

The certificate for drinking water is valid for the standard configuration, without joint.

The certification could be voided if the booster was sent, on request, complete with fitted joints.

For more information, please contact the sales network.

RUBBER EXPANSION JOINT

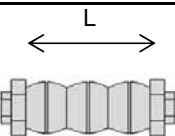
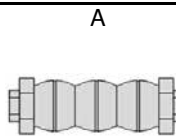
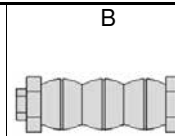
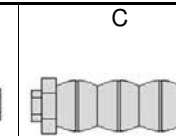
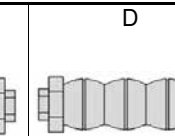
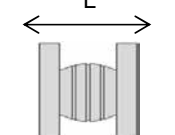
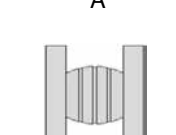
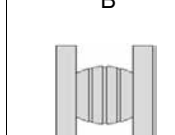
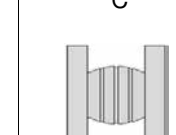
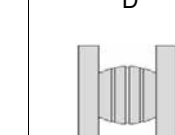
	L	A	B	C	D
DN	 (mm)	 (mm)	 (mm)	 (mm)	 (°)
1"	200	25	6	23	30
1"1/4	200	25	6	23	30
1"1/2	200	25	6	23	30
2"	200	25	6	23	20
2"1/2	225	25	6	23	15
DN	 (mm)	 (mm)	 (mm)	 (mm)	 (°)
32	95	8	4	8	15
40	95	8	4	8	15
50	105	8	5	8	15
65	115	12	6	10	15
80	130	12	6	10	15
100	135	18	10	12	15
125	170	18	10	12	15
150	180	18	10	12	15
200	205	25	14	22	15
250	240	25	14	22	15
300	260	25	14	22	15
350	265	25	16	22	15
400	265	25	16	22	15
450	265	25	16	22	15
500	265	25	16	22	15

GD_JOINT_B_TD

LEGEND

- A = compression
- B = extension
- C = transverse
- D = angular movement

NOTE. A - B - C - D can not be cumulative

PROTECTION SYSTEMS AGAINST DRY RUNNING

To avoid damaging the electric pumps, protection systems must be used to prevent it from dry running.

FLOAT SWITCH PROTECTION

The float switch system is used for supplies from open tanks. The float switch immersed in the tank must be connected to the control panel.

If there is no water, the float switch opens the electrical contact and the electric pumps stop.

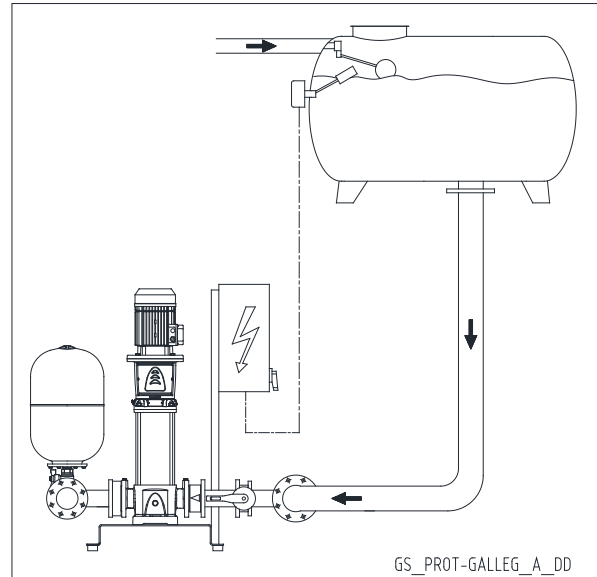

ELECTRODE PROBE PROTECTION

The system with electrode probes is used for supplies from open tanks or wells.

Three probes are directly connected to the electric module with adjustable sensitivity that can be installed in the control panel.

If there is no water, the control circuit opens the electrical contact and the electric pumps stop.

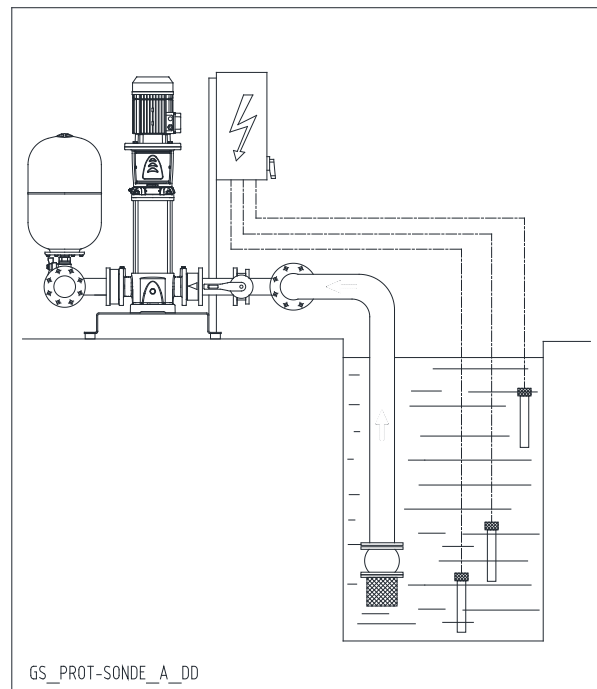

MINIMUM PRESSURE SWITCH PROTECTION

The system with minimum pressure switch is used for water supplies from pressurised networks or tanks. The pressure switch is connected to the control panel. In case of water shortage, it opens the electric contact, causing the stop of the electric pumps.

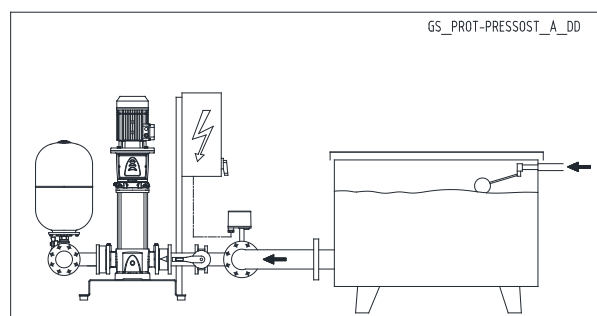

PROTECTION SENSOR AGAINST DRY RUNNING



Sensor for detecting the presence of water based on the optoelectronic principle, therefore non-invasive and with no moving parts. The sensor features an electronic contact (on/off) which stops the pump if there is no water in the seal area.

The sensor opens the electric contact if there is no water after they factory-set delay (10 seconds) elapses. The sensor is supplied as a kit complete with 2 metres of cable, an EPDM O-ring gasket and a stainless steel adapter.

General operating featuresgo

- **SENSOR KIT DRP-GP: 21÷27 Vca:** In the boosters sets the sensor is assembled on the suction manifold with a specific hydraulic fitting.
21÷27 Vca version, universal solid state output for external relay at 24 Vac (21÷27 Vac, 50 mA).
- **KIT SENSOR DRP-HV: 15÷25 Vcc:** The sensor can also be fitted directly on the filling cap of the e-SV pumps series. 15÷25 Vcc version, NPN output at 25 V (10 mA) for HYDROVAR inverter and e-SM drive.
- Operation is independent of the hardness and conductivity of the water. The sensor cannot detect frozen liquids.

Operating principle

Operation is based on the change in the refractive index on the surfaces. The optic sensor comprises a glass cap (C) containing a transmitter (T) and an infrared receiver (R).

If there is no liquid, all the infrared light emitted by the transmitter is internally reflected by the surface of the glass cap of the receiver. The electronic contact will be open.

If liquid is present, the refractive index of the surface changes. Most of the infrared light emitted by the transmitter is dispersed in the liquid. The receiver receives less light and the electronic contact is closed.

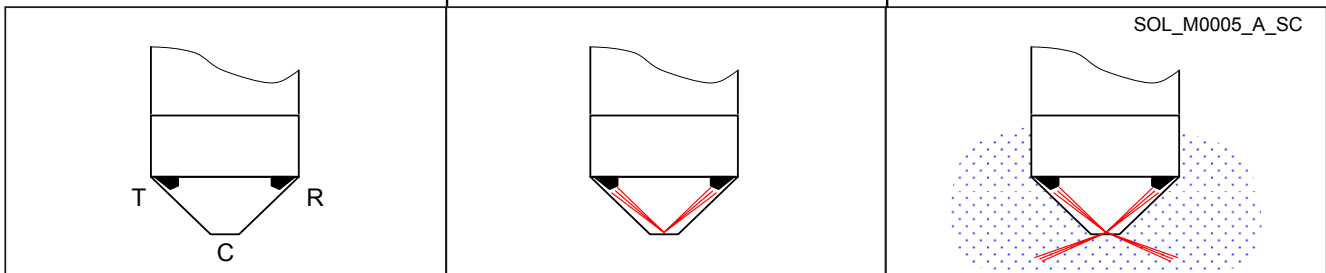

SPECIFICATIONS

- Materials:
 - Body in AISI 316L stainless steel
 - Glass optic cap
 - EPDM gasket
- Liquids: clean water, demi water. Operation is not affected by the hardness and conductivity of the liquid. To check the suitability of other liquids, contact the Lowara technical assistance service providing the characteristics of the liquid.
- Temperature of liquid: -20°C÷+120°C (cannot be used to detect frozen liquids).
- Ambient temperature: -5°C ÷ +50°C
- Maximum pressure (PN): 25 bar
- Connector: 3/8" (3/8" x 1/2" adaptor plug included in the Kit)
- Dimensions: 27x 60 mm
- IP55 protection
- Electrical characteristics:
 - Input voltage SENSOR KIT DRP-GP: 21÷27 Vac
SENSOR KIT DRP-HV: 15÷25 Vdc
 - Output SENSOR KIT DRP-GP: universal solid state 21÷27 Vac (50 mA) for 24 Vac external relay
SENSOR KIT DRP-HV: NPN 25 V (10 mA) for HYDROVAR inverter
 - Alarm delay: 10 seconds (factory setting)
 - FROR cable 4 x 0,34 mm² (PVC-CEI 20-22) 2 metres long.

WIRING DIAGRAM

SENSOR KIT DRP-GP (code 109394610)

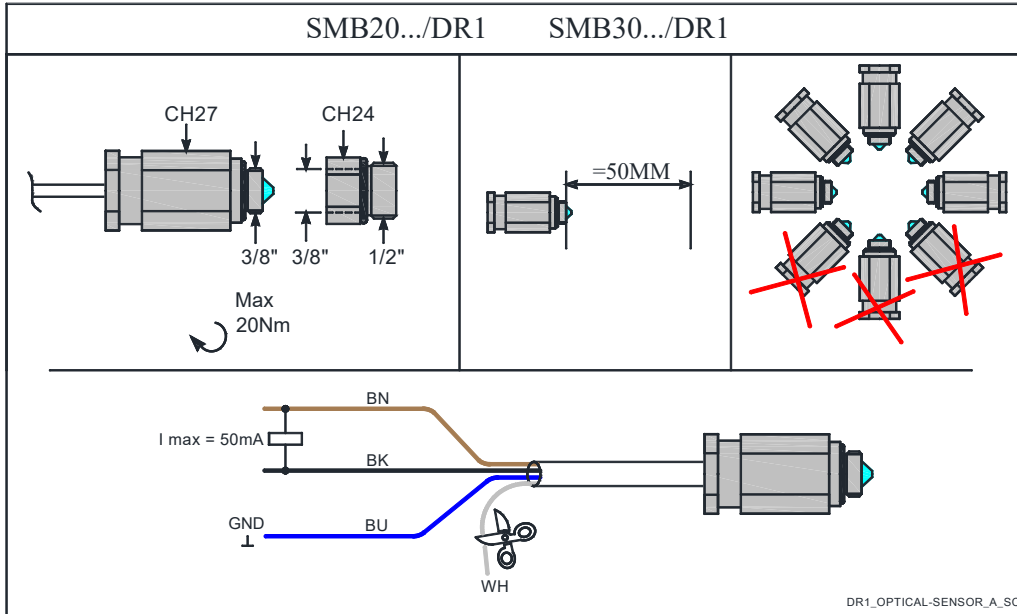

SENSOR KIT DRP-HV (code 109394600)

The sensor can be directly mounted on the filling plug of the e-SV pumps.
For the 33, 46, 66, 92, 125SV series, the 3/8" x 1/2" adaptor ring included in the Kit must also be mounted.

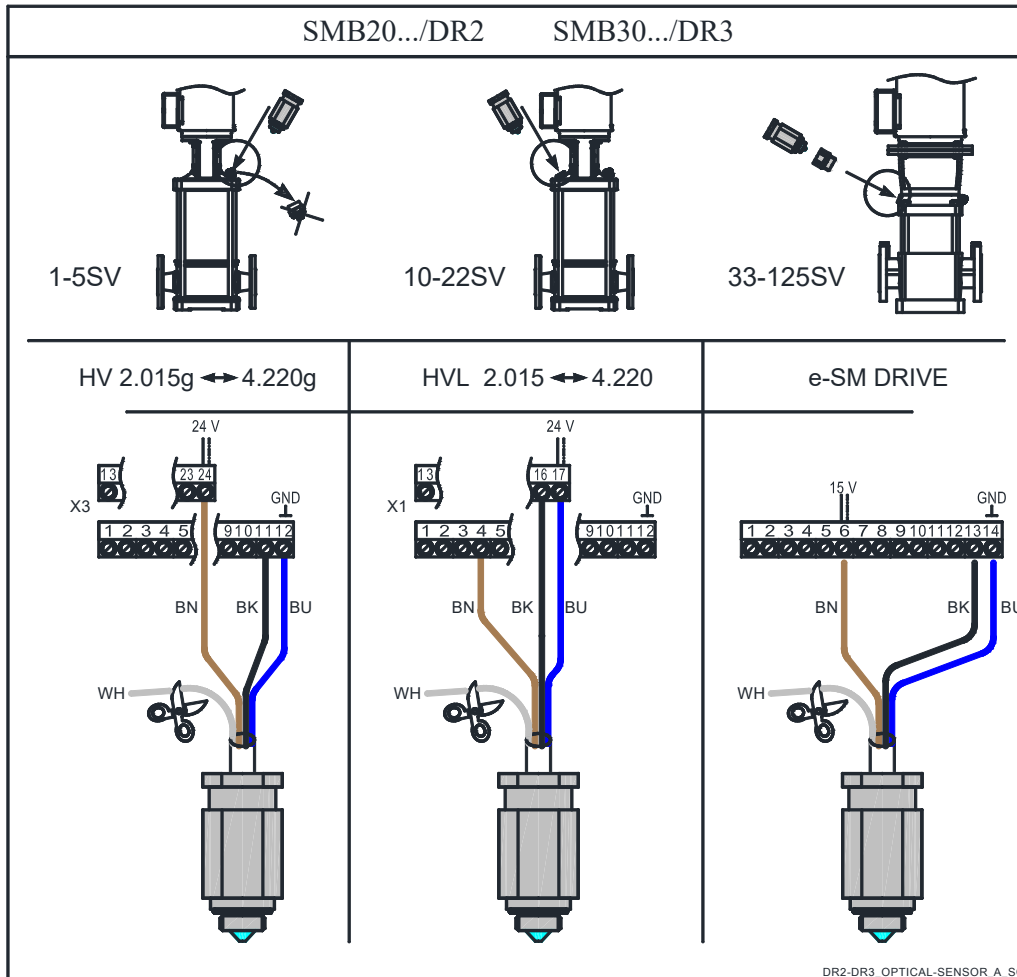

TECHNICAL APPENDIX

VAPOUR PRESSURE VAPOUR PRESSURE p_s AND ρ DENSITY OF WATER TABLE

t °C	T K	p_s bar	ρ kg/dm ³	t °C	T K	p_s bar	ρ kg/dm ³	t °C	T K	p_s bar	ρ kg/dm ³
0	273,15	0,00611	0,9998	55	328,15	0,15741	0,9857	120	393,15	1,9854	0,9429
1	274,15	0,00657	0,9999	56	329,15	0,16511	0,9852	122	395,15	2,1145	0,9412
2	275,15	0,00706	0,9999	57	330,15	0,17313	0,9846	124	397,15	2,2504	0,9396
3	276,15	0,00758	0,9999	58	331,15	0,18147	0,9842	126	399,15	2,3933	0,9379
4	277,15	0,00813	1,0000	59	332,15	0,19016	0,9837	128	401,15	2,5435	0,9362
5	278,15	0,00872	1,0000	60	333,15	0,1992	0,9832	130	403,15	2,7013	0,9346
6	279,15	0,00935	1,0000	61	334,15	0,2086	0,9826	132	405,15	2,867	0,9328
7	280,15	0,01001	0,9999	62	335,15	0,2184	0,9821	134	407,15	3,041	0,9311
8	281,15	0,01072	0,9999	63	336,15	0,2286	0,9816	136	409,15	3,223	0,9294
9	282,15	0,01147	0,9998	64	337,15	0,2391	0,9811	138	411,15	3,414	0,9276
10	283,15	0,01227	0,9997	65	338,15	0,2501	0,9805	140	413,15	3,614	0,9258
11	284,15	0,01312	0,9997	66	339,15	0,2615	0,9799	145	418,15	4,155	0,9214
12	285,15	0,01401	0,9996	67	340,15	0,2733	0,9793	155	428,15	5,433	0,9121
13	286,15	0,01497	0,9994	68	341,15	0,2856	0,9788	160	433,15	6,181	0,9073
14	287,15	0,01597	0,9993	69	342,15	0,2984	0,9782	165	438,15	7,008	0,9024
15	288,15	0,01704	0,9992	70	343,15	0,3116	0,9777	170	443,15	7,920	0,8973
16	289,15	0,01817	0,9990	71	344,15	0,3253	0,9770	175	448,15	8,924	0,8921
17	290,15	0,01936	0,9988	72	345,15	0,3396	0,9765	180	453,15	10,027	0,8869
18	291,15	0,02062	0,9987	73	346,15	0,3543	0,9760	185	458,15	11,233	0,8815
19	292,15	0,02196	0,9985	74	347,15	0,3696	0,9753	190	463,15	12,551	0,8760
20	293,15	0,02337	0,9983	75	348,15	0,3855	0,9748	195	468,15	13,987	0,8704
21	294,15	0,24850	0,9981	76	349,15	0,4019	0,9741	200	473,15	15,550	0,8647
22	295,15	0,02642	0,9978	77	350,15	0,4189	0,9735	205	478,15	17,243	0,8588
23	296,15	0,02808	0,9976	78	351,15	0,4365	0,9729	210	483,15	19,077	0,8528
24	297,15	0,02982	0,9974	79	352,15	0,4547	0,9723	215	488,15	21,060	0,8467
25	298,15	0,03166	0,9971	80	353,15	0,4736	0,9716	220	493,15	23,198	0,8403
26	299,15	0,03360	0,9968	81	354,15	0,4931	0,9710	225	498,15	25,501	0,8339
27	300,15	0,03564	0,9966	82	355,15	0,5133	0,9704	230	503,15	27,976	0,8273
28	301,15	0,03778	0,9963	83	356,15	0,5342	0,9697	235	508,15	30,632	0,8205
29	302,15	0,04004	0,9960	84	357,15	0,5557	0,9691	240	513,15	33,478	0,8136
30	303,15	0,04241	0,9957	85	358,15	0,5780	0,9684	245	518,15	36,523	0,8065
31	304,15	0,04491	0,9954	86	359,15	0,6011	0,9678	250	523,15	39,776	0,7992
32	305,15	0,04753	0,9951	87	360,15	0,6249	0,9671	255	528,15	43,246	0,7916
33	306,15	0,05029	0,9947	88	361,15	0,6495	0,9665	260	533,15	46,943	0,7839
34	307,15	0,05318	0,9944	89	362,15	0,6749	0,9658	265	538,15	50,877	0,7759
35	308,15	0,05622	0,9940	90	363,15	0,7011	0,9652	270	543,15	55,058	0,7678
36	309,15	0,05940	0,9937	91	364,15	0,7281	0,9644	275	548,15	59,496	0,7593
37	310,15	0,06274	0,9933	92	365,15	0,7561	0,9638	280	553,15	64,202	0,7505
38	311,15	0,06624	0,9930	93	366,15	0,7849	0,9630	285	558,15	69,186	0,7415
39	312,15	0,06991	0,9927	94	367,15	0,8146	0,9624	290	563,15	74,461	0,7321
40	313,15	0,07375	0,9923	95	368,15	0,8453	0,9616	295	568,15	80,037	0,7223
41	314,15	0,07777	0,9919	96	369,15	0,8769	0,9610	300	573,15	85,927	0,7122
42	315,15	0,08198	0,9915	97	370,15	0,9094	0,9602	305	578,15	92,144	0,7017
43	316,15	0,09639	0,9911	98	371,15	0,9430	0,9596	310	583,15	98,70	0,6906
44	317,15	0,09100	0,9907	99	372,15	0,9776	0,9586	315	588,15	105,61	0,6791
45	318,15	0,09582	0,9902	100	373,15	1,0133	0,9581	320	593,15	112,89	0,6669
46	319,15	0,10086	0,9898	102	375,15	1,0878	0,9567	325	598,15	120,56	0,6541
47	320,15	0,10612	0,9894	104	377,15	1,1668	0,9552	330	603,15	128,63	0,6404
48	321,15	0,11162	0,9889	106	379,15	1,2504	0,9537	340	613,15	146,05	0,6102
49	322,15	0,11736	0,9884	108	381,15	1,3390	0,9522	350	623,15	165,35	0,5743
50	323,15	0,12335	0,9880	110	383,15	1,4327	0,9507	360	633,15	186,75	0,5275
51	324,15	0,12961	0,9876	112	385,15	1,5316	0,9491	370	643,15	210,54	0,4518
52	325,15	0,13613	0,9871	114	387,15	1,6362	0,9476	374,15	647,30	221,20	0,3154
53	326,15	0,14293	0,9862	116	389,15	1,7465	0,9460				
54	327,15	0,15002	0,9862	118	391,15	1,8628	0,9445				

TABLE OF FLOW RESISTANCE IN 100 m OF STRAIGHT CAST IRON PIPELINE (HAZEN-WILLIAMS FORMULA C=100)

FLOW RATE			NOMINAL DIAMETER in mm and inches																
m³/h	l/min		15 1/2"	20 3/4"	25 1"	32 1 1/4"	40 1 1/2"	50 2	65 2 1/2"	80 3"	100 4"	125 5"	150 6"	175 7"	200 8"	250 10"	300 12"	350 14"	400 16"
0,6	10	v hr	0,94 16	0,53 3,94	0,34 1,33	0,21 0,40	0,13 0,13												
0,9	15	v hr	1,42 33,9	0,80 8,35	0,51 2,82	0,31 0,85	0,20 0,29												
1,2	20	v hr	1,89 57,7	1,06 14,21	0,68 4,79	0,41 1,44	0,27 0,49	0,17 0,16											
1,5	25	v hr	2,36 87,2	1,33 21,5	0,85 7,24	0,52 2,18	0,33 0,73	0,21 0,25											
1,8	30	v hr	2,83 122	1,59 30,1	1,02 10,1	0,62 3,05	0,40 1,03	0,25 0,35											
2,1	35	v hr	3,30 162	1,86 40,0	1,19 13,5	0,73 4,06	0,46 1,37	0,30 0,46											
2,4	40	v hr		2,12 51,2	1,36 17,3	0,83 5,19	0,53 1,75	0,34 0,59	0,20 0,16										
3	50	v hr		2,65 77,4	1,70 26,1	1,04 7,85	0,66 2,65	0,42 0,89	0,25 0,25										
3,6	60	v hr		3,18 108	2,04 36,6	1,24 11,0	0,80 3,71	0,51 1,25	0,30 0,35										
4,2	70	v hr		3,72 144	2,38 48,7	1,45 14,6	0,93 4,93	0,59 1,66	0,35 0,46										
4,8	80	v hr		4,25 185	2,72 62,3	1,66 18,7	1,06 6,32	0,68 2,13	0,40 0,59										
5,4	90	v hr			3,06 77,5	1,87 23,3	1,19 7,85	0,76 2,65	0,45 0,74	0,30 0,27									
6	100	v hr			3,40 94,1	2,07 28,3	1,33 9,54	0,85 3,22	0,50 0,90	0,33 0,33									
7,5	125	v hr			4,25 142	2,59 42,8	1,66 14,4	1,06 4,86	0,63 1,36	0,41 0,49									
9	150	v hr				3,11 59,9	1,99 20,2	1,27 6,82	0,75 1,90	0,50 0,23	0,32 0,23								
10,5	175	v hr				3,63 79,7	2,32 26,9	1,49 9,07	0,88 2,53	0,58 0,92	0,37 0,31								
12	200	v hr				4,15 102	2,65 34,4	1,70 11,6	1,01 3,23	0,66 1,18	0,42 0,40								
15	250	v hr				5,18 154	3,32 52,0	2,12 17,5	1,26 4,89	0,83 1,78	0,53 0,60	0,34 0,20							
18	300	v hr				3,98 72,8	2,55 24,6	1,51 6,85	1,00 2,49	0,64 0,84	0,41 0,28								
24	400	v hr				5,31 124	3,40 41,8	2,01 11,66	1,33 4,24	0,85 1,43	0,54 0,48	0,38 0,20							
30	500	v hr				6,63 187	4,25 63,2	2,51 17,6	1,66 6,41	1,06 2,16	0,68 0,73	0,47 0,30							
36	600	v hr					5,10 88,6	3,02 24,7	1,99 8,98	1,27 3,03	0,82 1,02	0,57 0,42	0,42 0,20						
42	700	v hr					5,94 118	3,52 32,8	2,32 11,9	1,49 4,03	0,95 1,36	0,66 0,56	0,49 0,26						
48	800	v hr					6,79 151	4,02 42,0	2,65 15,3	1,70 5,16	1,09 1,74	0,75 0,72	0,55 0,34						
54	900	v hr					7,64 188	4,52 52,3	2,99 19,0	1,91 6,41	1,22 2,16	0,85 0,89	0,62 0,42						
60	1000	v hr						5,03 63,5	3,32 23,1	2,12 7,79	1,36 2,63	0,94 1,08	0,69 0,51	0,53 0,27					
75	1250	v hr						6,28 96,0	4,15 34,9	2,65 11,8	1,70 3,97	1,18 1,63	0,87 0,77	0,66 0,40					
90	1500	v hr						7,54 134	4,98 48,9	3,18 16,5	2,04 5,57	1,42 2,29	1,04 1,08	0,80 0,56					
105	1750	v hr						8,79 179	5,81 65,1	3,72 21,9	2,38 7,40	1,65 3,05	1,21 1,44	0,93 0,75					
120	2000	v hr							6,63 83,3	4,25 28,1	2,72 9,48	1,89 3,90	1,39 1,84	1,06 0,96	0,68 0,32				
150	2500	v hr							8,29 126	5,31 42,5	3,40 14,3	2,36 5,89	1,73 2,78	1,33 1,45	0,85 0,49				
180	3000	v hr								6,37 59,5	4,08 20,1	2,83 8,26	2,08 3,90	1,59 2,03	1,02 0,69	0,71 0,28			
210	3500	v hr								7,43 79,1	4,76 26,7	3,30 11,0	2,43 5,18	1,86 2,71	1,19 0,91	0,83 0,38			
240	4000	v hr								8,49 101	5,44 34,2	3,77 14,1	2,77 6,64	2,12 3,46	1,36 1,17	0,94 0,48			
300	5000	v hr									6,79 51,6	4,72 21,2	3,47 10,0	2,65 5,23	1,70 1,77	1,18 0,73			
360	6000	v hr									8,15 72,3	5,66 29,8	4,16 14,1	3,18 7,33	2,04 2,47	1,42 1,02			
420	7000	v hr										6,61 39,6	4,85 18,7	3,72 9,75	2,38 3,29	1,65 1,35	1,21 0,64		
480	8000	v hr										7,55 50,7	5,55 23,9	4,25 12,49	2,72 4,21	1,89 1,73	1,39 0,82		
540	9000	v hr										8,49 63,0	6,24 29,8	4,78 15,5	3,06 5,24	2,12 2,16	1,56 1,02	1,19 0,53	
600	10000	v hr											6,93 36,2	5,31 18,9	3,40 6,36	2,36 2,62	1,73 1,24	1,33 0,65	

The hr values must be multiplied by:
 0,71 for galvanized or painted steel pipes
 0,54 for stainless steel or copper pipes
 0,47 for PVC or PE pipes

hr = flow resistance for 100 m of straight pipeline (m) G-at-pct-en_b_th
 V = water speed (m/s)

FLOW RESISTANCE TABLE OF FLOW RESISTANCE IN BENDS, VALVES AND GATES

The flow resistance is calculated using the equivalent pipeline length method according to the table below:

ACCESSORY TYPE	DN											
	25	32	40	50	65	80	100	125	150	200	250	300
	Equivalent pipeline length (m)											
45° bend	0,2	0,2	0,4	0,4	0,6	0,6	0,9	1,1	1,5	1,9	2,4	2,8
90° bend	0,4	0,6	0,9	1,1	1,3	1,5	2,1	2,6	3,0	3,9	4,7	5,8
90° smooth bend	0,4	0,4	0,4	0,6	0,9	1,1	1,3	1,7	1,9	2,8	3,4	3,9
Union tee or cross	1,1	1,3	1,7	2,1	2,6	3,2	4,3	5,3	6,4	7,5	10,7	12,8
Gate valve	-	-	-	0,2	0,2	0,2	0,4	0,4	0,6	0,9	1,1	1,3
Foot check valve	1,1	1,5	1,9	2,4	3,0	3,4	4,7	5,9	7,4	9,6	11,8	13,9
Non return valve	1,1	1,5	1,9	2,4	3,0	3,4	4,7	5,9	7,4	9,6	11,8	13,9

G-a-pcv-en_b_th

The table is valid for the Hazen Williams coefficient $C=100$ (cast iron pipework)
for galvanized steel or painted steel multiply the values by 0,71;
for stainless steel and copper multiply the values by 0,54;
for Pvc and PE multiply the values by 0,47.

When the **equivalent pipeline length** has been determined, the flow resistance is obtained from the table in the previous page.

The values given are guideline values which are bound to vary slightly according to the model, especially for gate valves and non-return valves, for which it is a good idea to check the values supplied by manufacturers.

TANK

CHOOSING AND SIZING THE SURGE TANK

The purpose of the surge tank is to limit the number of hourly starts of the electric pumps, placing part of its stock of water, which is maintained under pressure by the air above it, at the disposal of the system.

The surge tank can be of the air cushion or diaphragm type.

In the air cushion version there is no clear separation between air and water.

Since part of the air tends to mix with water, it is necessary to restore it by means of air supply units or a compressor.

In the diaphragm version, neither air supply units nor compressor are needed, as contact between air and water is prevented by a flexible diaphragm inside the tank.

The following method, which is used to determine the volume of a surge tank, is valid both for horizontal and vertical surge tanks.

When calculating the volume of the surge tank, it is generally sufficient to consider the first electric pump only.

DIAPHRAGM TANK

If you decide to use a diaphragm tank, the volume will be lower than that of the air-cushion tank. It can be calculated with the following formula:

$$V_m = \frac{Q_p}{4 \times Z} \times \frac{1}{1 - \frac{(P_{min} - 2)}{P_{max}}}$$

where:

V_m = Total volume of the air-cushion surge tank in m^3

Q_p = Average electric pump flow rate in m^3/h

P_{max} = Maximum pressure setting (wcm)

P_{min} = Minimum pressure setting (wcm)

Z = Maximum number of starts per hour allowed by the motor

Example:

22SV10F110T electric pump

P_{max} = 23 wcm

P_{min} = 15 wcm

Q_p = 20 m^3/h

Z = 25

$$V_m = \frac{Q_p}{4 \times Z} \times \frac{1}{1 - \frac{(P_{min} - 2)}{P_{max}}} = 0,46 \text{ m}^3$$

A 500-litre surge tank is therefore required.

VOLUMETRIC CAPACITY

Litres per minute l/min	Cubic metres per hour m ³ /h	Cubic feet per hour ft ³ /h	Cubic feet per minute ft ³ /min	Imperial gallon per minute Imp. gal/min	U.S. gallon per minute US gal/min
1,000	0,0600	2,1189	0,0353	0,2200	0,2642
16,6667	1,000	35,3147	0,5886	3,6662	4,4029
0,4719	0,0283	1,000	0,0167	0,1038	0,1247
28,3168	1,6990	60,0000	1,000	6,2288	7,4805
4,5461	0,2728	9,6326	0,1605	1,000	1,2009
3,7854	0,2271	8,0208	0,1337	0,8327	1,000

PRESSURE AND HEAD

Newton per square metre N/m ²	kilo Pascal kPa	bar bar	Pound force per square inch psi	Metre of water m H ₂ O	Millimetre of mercury mm Hg
1,000	0,0010	1 x 10 ⁻⁵	1,45 x 10 ⁻⁴	1,02 x 10 ⁻⁴	0,0075
1 000,0000	1,000	0,0100	0,1450	0,1020	7,5006
1 x 10 ⁵	100,0000	1,000	14,5038	10,1972	750,0638
6 894,7570	6,8948	0,0689	1,000	0,7031	51,7151
9 806,6500	9,8067	0,0981	1,4223	1,000	73,5561
133,3220	0,1333	0,0013	0,0193	0,0136	1,000

LENGTH

Millimetre mm	Centimetre cm	Metre m	Inch in	Foot ft	Yard yd
1,000	0,1000	0,0010	0,0394	0,0033	0,0011
10,0000	1,000	0,0100	0,3937	0,0328	0,0109
1 000,0000	100,0000	1,000	39,3701	3,2808	1,0936
25,4000	2,5400	0,0254	1,000	0,0833	0,0278
304,8000	30,4800	0,3048	12,0000	1,000	0,3333
914,4000	91,4400	0,9144	36,0000	3,0000	1,000

VOLUME

Cubic metre m ³	Litre L	Millilitre ml	Imperial gallon imp. gal.	U.S. gallon US gal.	Cubic foot ft ³
1,000	1 000,0000	1 x 10 ⁶	219,9694	264,1720	35,3147
0,0010	1,000	1 000,0000	0,2200	0,2642	0,0353
1 x 10 ⁻⁶	0,0010	1,000	2,2 x 10 ⁻⁴	2,642 x 10 ⁻⁴	3,53 x 10 ⁻⁵
0,0045	4,5461	4 546,0870	1,000	1,2009	0,1605
0,0038	3,7854	3 785,4120	0,8327	1,000	0,1337
0,0283	28,3168	28 316,8466	6,2288	7,4805	1,000

TEMPERATURE

Water	Kelvin K	Celsius °C	Fahrenheit °F	$^{\circ}\text{F} = ^{\circ}\text{C} \times \frac{9}{5} + 32$ $^{\circ}\text{C} = (^{\circ}\text{F} - 32) \times \frac{5}{9}$
icing	273,1500	0,0000	32,0000	
boiling	373,1500	100,0000	212,0000	

G-at_pp-en_b_sc

FURTHER PRODUCT SELECTION AND DOCUMENTATION Xylect

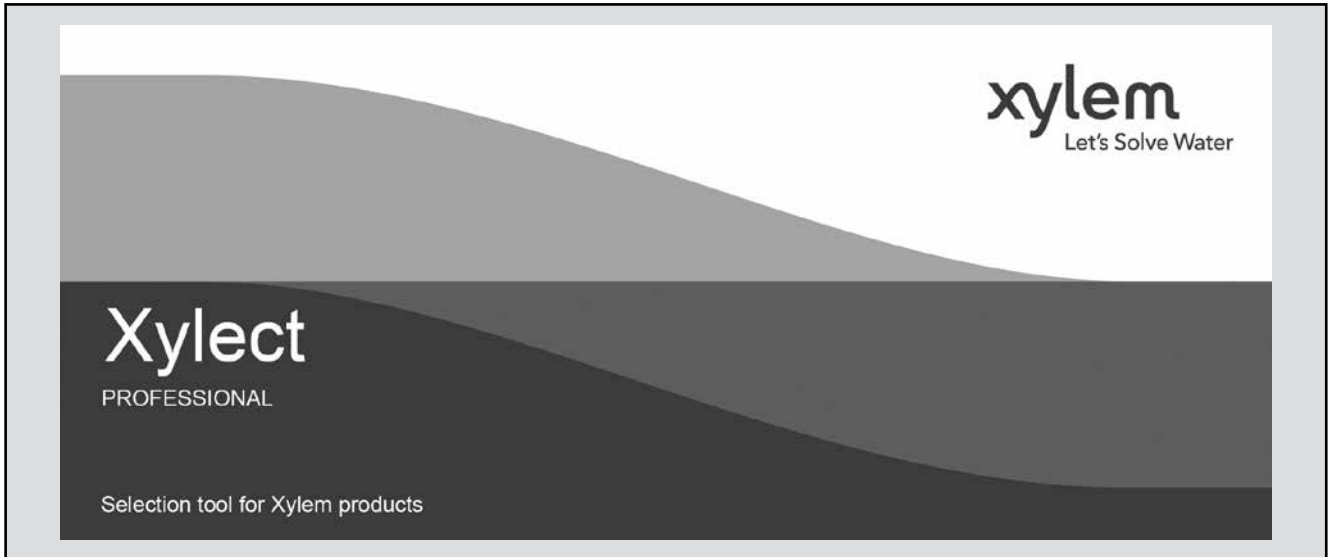

Xylect is electric pump solution selection software with an extensive online database of product information across the entire Lowara range of electric pumps and related products, with multiple search options and helpful project management facilities. The system holds up-to-date product information on thousands of products and accessories.

The possibility to search by applications and the detailed information output given makes it easy to make the optimal selection without having detailed knowledge about the Lowara products.

The search can be made by:

- Application
- Product type
- Duty point

Xylect gives a detailed output:

- List with search results
- Performance curves (flow, head, power, efficiency, NPSH)
- Motor data
- Dimensional drawings
- Options
- Data sheet printouts
- Document downloads incl dxf files

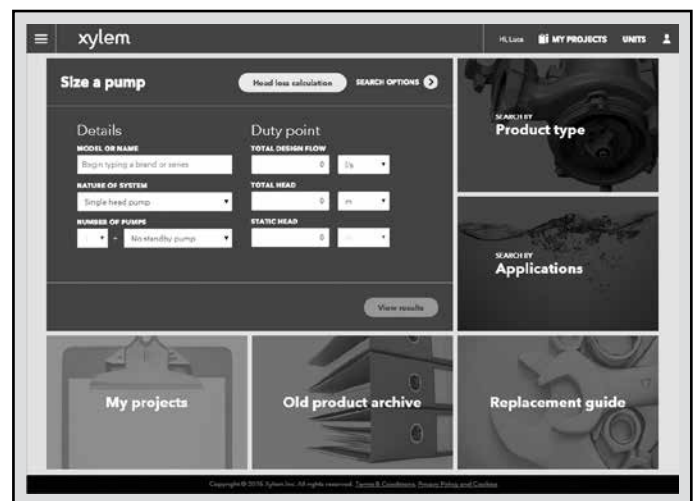

The search by application guides users not familiar with the product range to the right choice.

FURTHER PRODUCT SELECTION AND DOCUMENTATION Xylect



The detailed output makes it easy to select the optimal electric pump from the given alternatives.

The best way to work with Xylect is to create a personal account. This makes it possible to:

- Set own standard units
- Create and save projects
- Share projects with other Xylect users

Every registered user has a proper space, where all projects are saved.

For more information about Xylect please contact our sales network or visit www.xylect.com.

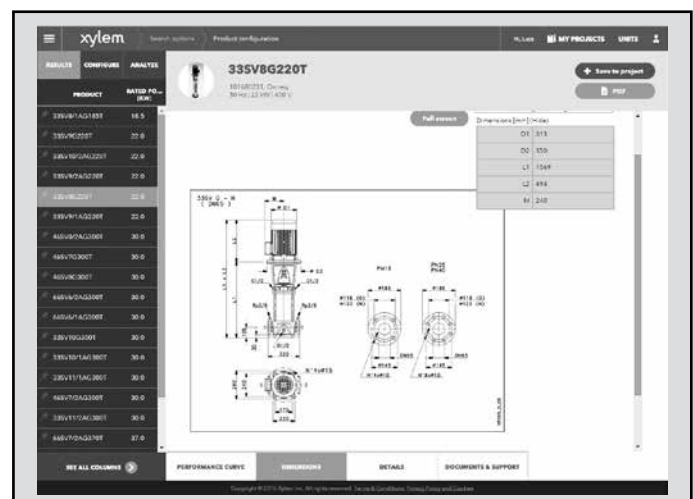

Dimensional drawings appear on the screen and can be downloaded in dxf format.

Xylem |'zīləm|

- 1) The tissue in plants that brings water upward from the roots;
- 2) a leading global water technology company.

We're a global team unified in a common purpose: creating advanced technology solutions to the world's water challenges. Developing new technologies that will improve the way water is used, conserved, and re-used in the future is central to our work. Our products and services move, treat, analyze, monitor and return water to the environment, in public utility, industrial, residential and commercial building services settings. Xylem also provides a leading portfolio of smart metering, network technologies and advanced analytics solutions for water, electric and gas utilities. In more than 150 countries, we have strong, long-standing relationships with customers who know us for our powerful combination of leading product brands and applications expertise with a strong focus on developing comprehensive, sustainable solutions.

For more information on how Xylem can help you, go to www.xylem.com.



Hauptsitz

Gloor Pumpenbau AG
Thunstrasse 25
CH-3113 Rubigen
Tel. +41 (0)58 255 43 34
info@gloor-pumpen.ch
www.gloor-pumpen.ch

Filiale Mittelland

Gloor Pumpenbau AG
Industriestrasse 25
CH-5036 Oberentfelden



Filiale Suisse Romande

Gloor Pumpenbau SA
Rue du Collège 3 | Case postale
CH-1410 Thierrens
Tél. +41 (0)58 255 43 34
info@gloor-pompes.ch
www.gloor-pompes.ch